

TOSHIBA

LIQUID CRYSTAL DISPLAY
PRODUCT INFORMATION

15cm FULL-COLOR
TFT-LCD MONITOR MODULE
TFD58W22MW

1. FEATURE

- (1) 15cm (5.8 inch) diagonal and wide display. (The ratio 16(W) : 9(H))
- (2) High resolution display. (400(W) x 234(H) pixel)
- (3) High luminance. (350 cd/m²)
- (4) Wide viewing angle spec.
- (5) Wide range temperature. (operating : -20 to +60°C, storage : -40 to +85°C)
- (6) Anti-glare surface.
- (7) Composite video signal (NTSC/PAL) and analog RGB signal (NTSC/PAL) interface.
- (8) +9.0V single power supply.

2. MECHANICAL SPECIFICATIONS

ITEM		SPECIFICATION	UNIT
DISPLAY SIZE		15 cm diagonal (5.8 inch)	-
CONTENTS		TFT-cell, Drivers, Timing controller, Video interface, Backlight, Power supply(DC/DC), Inverter(DC/AC)	-
DISPLAY MODE		TN Full-color, a-Si TFT active matrix, Normally-white	-
POWER SUPPLY		+ 9.0 V (single power supply)	V
INPUT SIGNALS	SIGNAL	*NTSC/PAL Composite video signal *NTSC/PAL Analog RGB signal and Composite sync.	-
	CONTROL	Direction rev.,Signal select,Display mode	-
NUMBER OF PIXELS		400(W) x 234(H)	-
NUMBER OF SUB PIXELS		1200(W) x 234(H)	-
PIXEL ARRANGEMENT		RGB stripe (Fig.A)	-
ACTIVE AREA		127.2(W) x 71.8(H)	mm
PIXEL PITCH		0.318(W) x 0.307(H)	mm
DIMENSIONAL OUTLINE		145.0(W) x 89.0(H) x 15.8max.(D)	mm
WEIGHT		210 max.	g
BACKLIGHT		CCFL edge light , Dimming ratio 3 to 100%	-
VIEWING DIRECTION		Maximum contrast ratio at 12 o'clock (Fig.B)	-
SURFACE TREATMENT		Anti-glare coating on LCD panel surface	-

Figure B : Viewing direction : 12 O'clock (Max. contrast ratio)

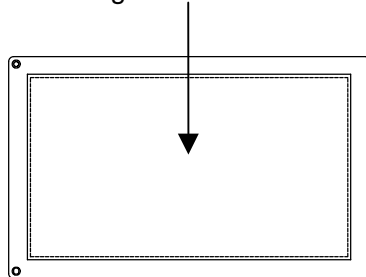

- ◆ The information contained herein is presented only as a guide for the applications of our products. No responsibility is assumed by TOSHIBA for any infringement of patents or other rights of the third parties which may result from its use. No license is granted by implication or otherwise under any patent rights of TOSHIBA or others.
- ◆ The information contained herein may be changed without prior notice. It's therefore, advisable to contact to TOSHIBA before proceeding with the design of equipment incorporating this product.

No.PE-TFD58W22MW 2000-12-12

Fig.A : Pixel Arrangement

	1	2	3	4	5		1197	1198	1199	1200
1	R	G	B	R	G		B	R	G	B
2	R	G	B	R	G		B	R	G	B
233	R	G	B	R	G		B	R	G	B
234	R	G	B	R	G		B	R	G	B

3. MAXIMUM ABSOLUTE RATING

ITEMS	SYMBOL	CONDITIONS	ABSOLUTE MAXIMUM RATINGS		UNIT	Remarks	
			MIN.	MAX.			
SUPPLY POWER VOLTAGE	for Video Circuit	V_{CC}	$T_a=25\pm 5^\circ\text{C}$ $V_{SS}=0\text{V}$	$V_{SS} -0.2$	+13.0	V	
	for B/L Inverter	V_{BL}		$V_{SS} -0.2$	+10.9	V	
INPUT SIGNAL VOLTAGE	Composite Video	VIDEO	$T_a=25\pm 5^\circ\text{C}$ $V_{SS}=0\text{V}$ $V_{CC} =9.0\text{V}$ $V_{BL} =9.0\text{V}$ 75Ω	-	1.5	V(p-p)	
	Analog RGB	R,G,B		-	1.5	V(p-p)	
	Composite sync.	SYNC		-	1.5	V(p-p)	
	Color,Tint Bright Dimmer	COLOR TINT,BRT DIM	$T_a=25\pm 5^\circ\text{C}$ $V_{SS}=0\text{V}$ $V_{CC} =9.0\text{V}$ $V_{BL} =9.0\text{V}$	$V_{SS} -0.2$	$V_{DD} +0.2$	V	
	Signal Switch	SSW,VSW MODE1,2,3 L/R,U/D		$V_{SS} -0.2$	$V_{DD} +0.2$	V	
OPERATING TEMP.	T_{op}	-	- 20	+ 60	$^\circ\text{C}$	Note 2,3	
STORAGE TEMP.	T_{stg}	-	- 40	+ 85	$^\circ\text{C}$	Note 2	

Note 1 : Do not exceed the maximum rating values under the worst probable conditions taking in to account the supply voltage variation, input voltage variation, variation in part constants, and ambient temperature and so on. Otherwise the module may be damaged.

Note 2 : Environmental temperature.
(Environmental temperature when cased with external size bigger than LCD by 5mm per each dimension.)

Note 3 : The temperature of the module rises under the influence of the backlight.
please design that sny parts of this monitor module dose not to exceed 85°C .

4. DIMENSIONAL OUTLINE

Figure 1. Front View

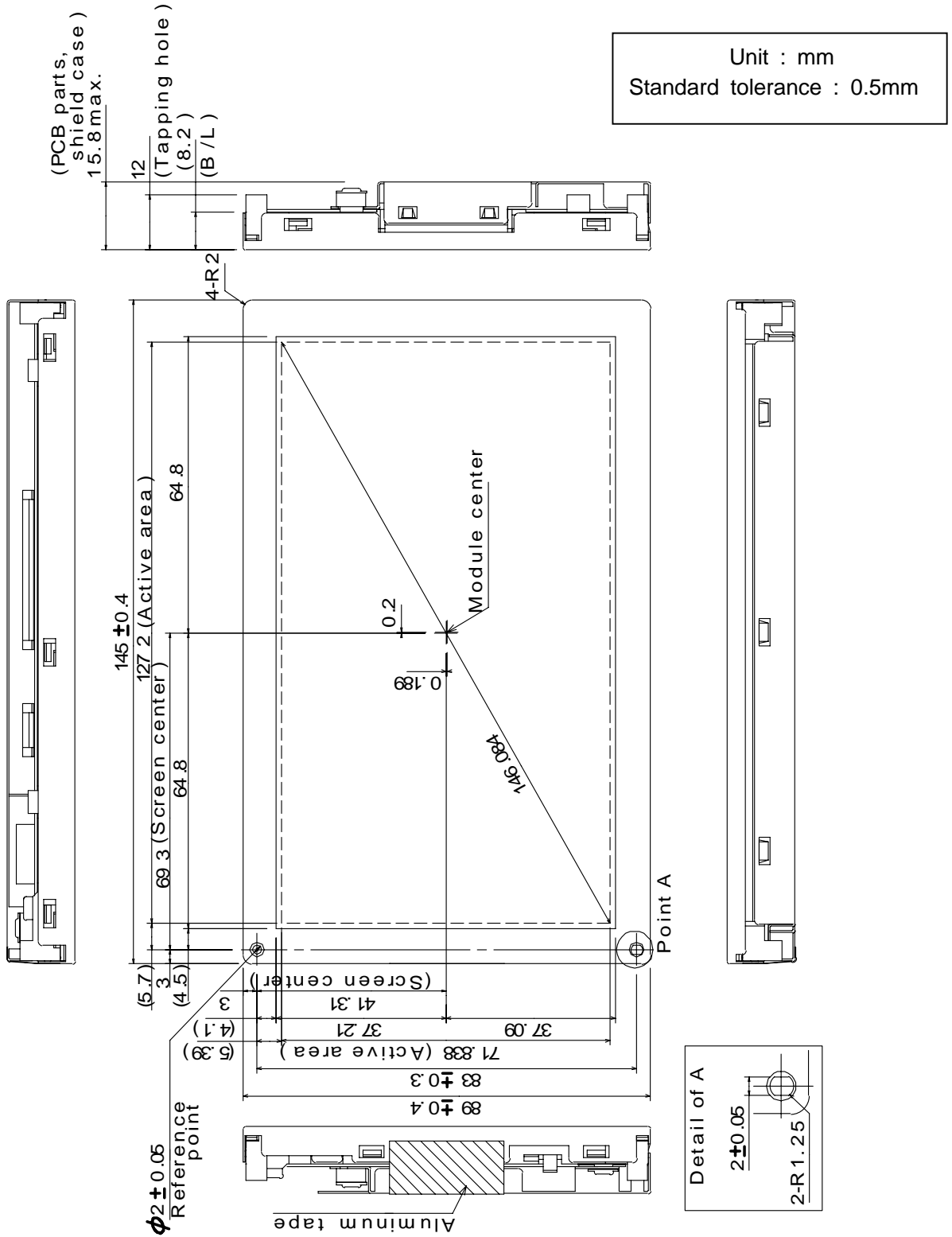

5. INTERFACE PIN ASSIGNMENT

[CN1] Connector : 52207-3090 (Japan Molex)

No.	Symbol	Functions	I/O	Remarks
1	VIDEO	Composite Video Input (1.0Vp-p 75Ω)	Input	
2	NC	No Connection	-	Note 6
3	V _{ss}	Ground (0V)	-	
4	SYNC	Composite Sync. Input (Negative 1.0Vp-p 75Ω)	Input	Note 2
5	R	Video Input R (0.7Vp-p 75Ω)	Input	
6	G	Video Input G (0.7Vp-p 75Ω)	Input	
7	B	Video Input B (0.7Vp-p 75Ω)	Input	
8	V _{ss}	Ground (0V)	-	
9	HSY	Horizontal Sync. Output (Negative C-MOS 5.0V)	Output	
10	VSY	Vertical Sync. Output (Negative C-MOS 5.0V)	Output	
11	NC	No Connection	-	Note 6
12	NC	No Connection	-	Note 6
13	NC	No Connection	-	Note 6
14	NC	No Connection	-	Note 6
15	V _{ss}	Ground (0V)	-	
16	SSW	Sync. Signal Selection Switch (0V:Composite Video , 5V:RGB)	Input	
17	N/P	NTSC/PAL Selection Switch (0V:NTSC , 5V:PAL)	Input	Note 5
18	V _{ss}	Ground (0V)	-	
19	V _{DD}	5V Output for Control Terminals	Output	
20	L/R	Scanning Direction Switch[0V:Normal,5V:Reverse(Left and Right)]	Input	Note 4
21	U/D	Scanning Direction Switch[0V:Normal,5V:Reverse(Up and Down)]	Input	Note 3
22	BRT	Brightness Control (0V to 5V)	Input	
23	DIM	Dimmer Control (1.35V to 3.9V)	Input	
24	COLOR	Color Control (0V to 5V)	Input	
25	TINT	Tint Control (0V to 5V)	Input	
26	VSW	Video Signal Selection Switch (0V:Composite Video , 5V:RGB)	Input	
27	MODE 1	Display Mode Selection Switch (Refer to table 1 : Next page)	Input	Note 1
28	MODE 2			
29	MODE 3			
30	NC	No Connection	-	Note 6

Note 1 : Display mode can be selected with the input level of pin no.27 to 29 of CN1.(Page.6)

Note 2 : Please input the sync. signal based on NTSC or PAL system.

Note 3 : U/D (pin no.21 of CN1) is vertical scanning direction switch.

Note 4 : L/R (pin no.20 of CN1) is horizontal scanning direction switch.

Note 5 : N/P (pin no.17 of CN1) is selection switch of NTSC or PAL.

Note 6 : (NC) terminal should not be connected to any signals or power supply lines.

[CN2] Connector : 52207-0690 (Japan Molex)

No.	Symbol	Functions	I/O	Remarks
1	V _{BL}	Power Supply (+9.0V) for Backlight Inverter	Input	
2				
3	V _{BL} -GND	Ground (0V) for Backlight	-	
4				
5	V _{CC} -GND	Ground (0V) for Video Circuit	-	
6	V _{CC}	Power Supply (+9.0V) for Video Circuit	Input	

Note : The ground of power supply between inverter unit and video unit are separated.

Table 1 : Display mode

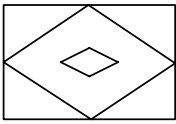
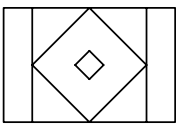
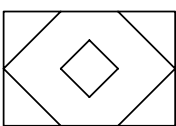
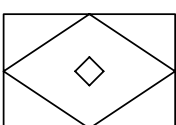
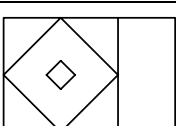
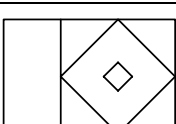
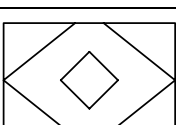
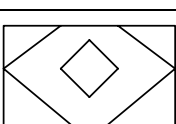
Display mode	Display (input signal of 4:3 aspect ratio)	Pin 27	Pin 28	Pin 29	Note
		MODE1	MODE2	MODE3	
Full		Lo	Lo	Lo	Input video signals are displayed in full screen.
Normal center		Hi	Lo	Lo	Input video signals are displayed in the center screen. (4:3 aspect ratio)
Zoom1		Hi	Hi	Lo	Input video signal of central 176 lines are displayed in full screen. (Vertically extension)
Wide		Lo	Hi	Lo	Input video signals are displayed in full screen. (Horizontal modification)
Normal left		Hi	Lo	Hi	Input video signals are displayed in the left screen. (4:3 aspect ratio)
Normal right		Lo	Hi	Hi	Input video signals are displayed in the right screen. (4:3 aspect ratio)
Zoom2		Lo	Lo	Hi	Input video signal of central 204 lines are displayed in full screen. (Vertically extension and horizontal modification)
Zoom3		Hi	Hi	Hi	Same as Zoom2 mode vertically offset centered.

6. CIRCUIT BLOCK DIAGRAM

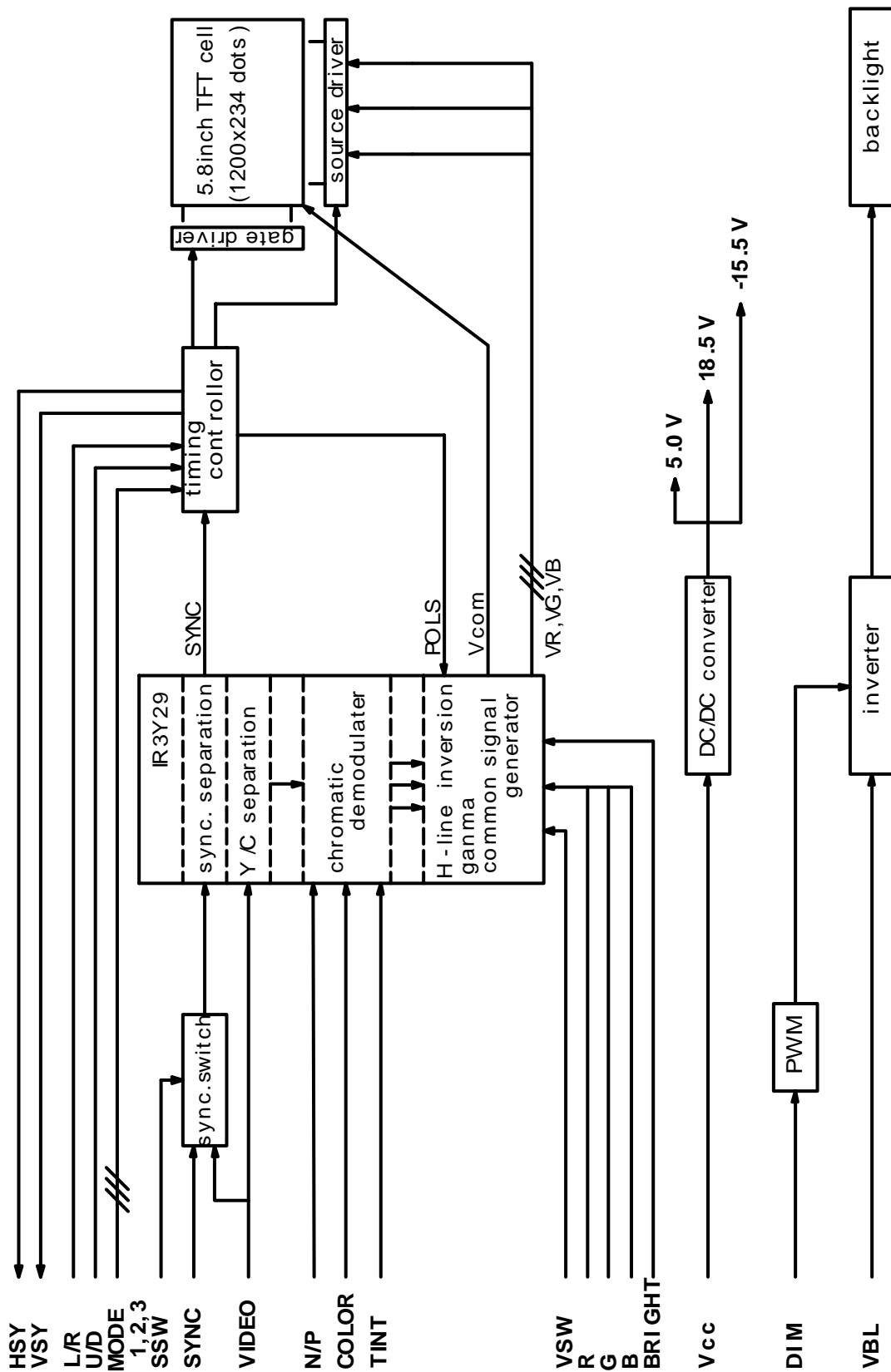

7. TIMING CHART

[Horizontal] Composite video (NTSC / PAL)

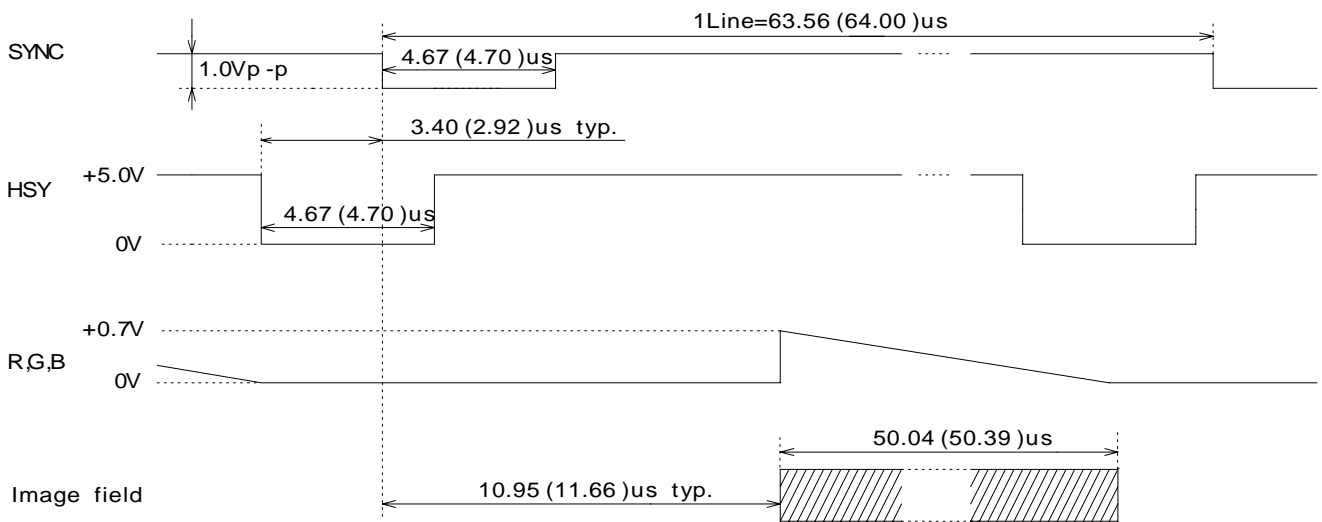

Note 1 : Value in brackets correspond to PAL mode.

[Horizontal] Analog RGB (NTSC / PAL)

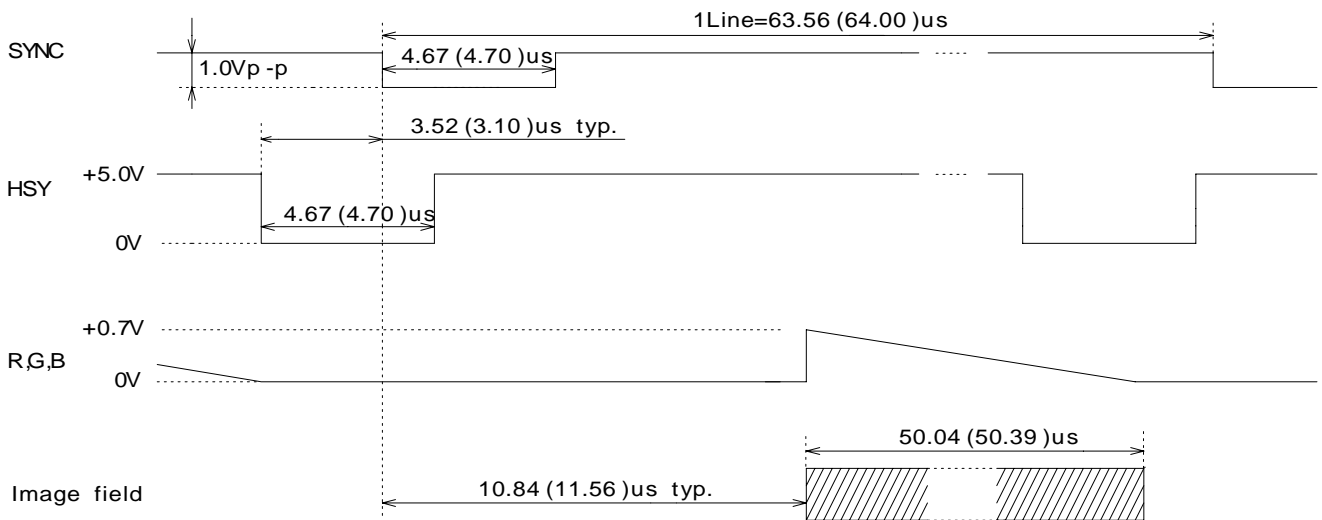

Note 1 : Value in brackets correspond to PAL mode.

[Vertical] Analog RGB / Composite video (NTSC)

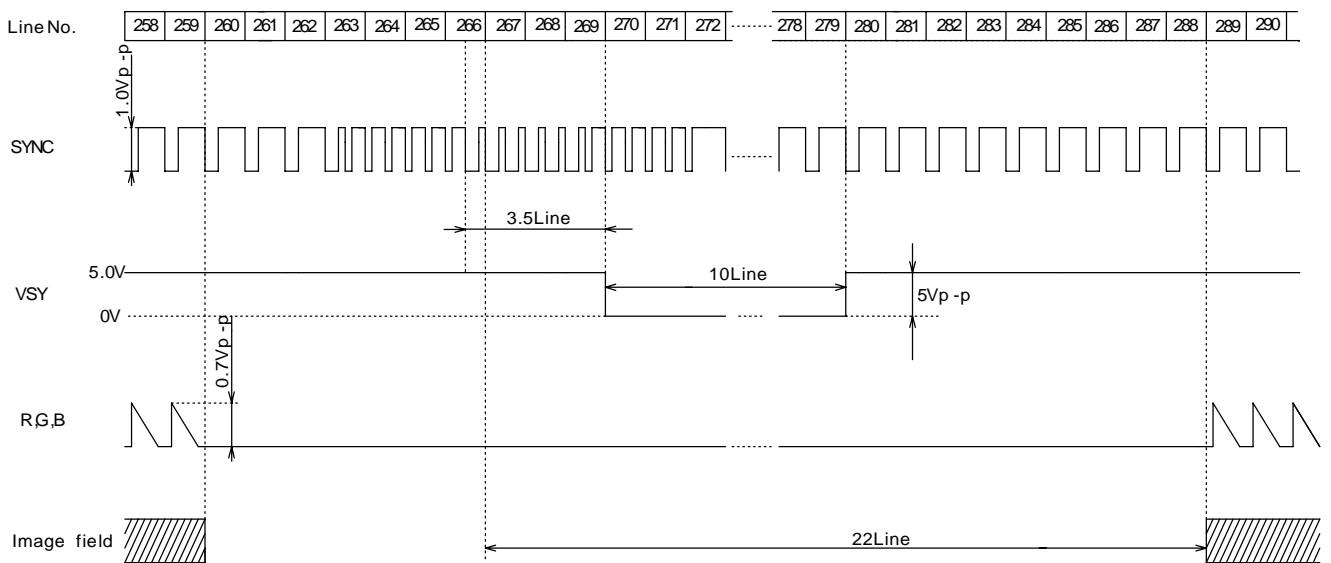
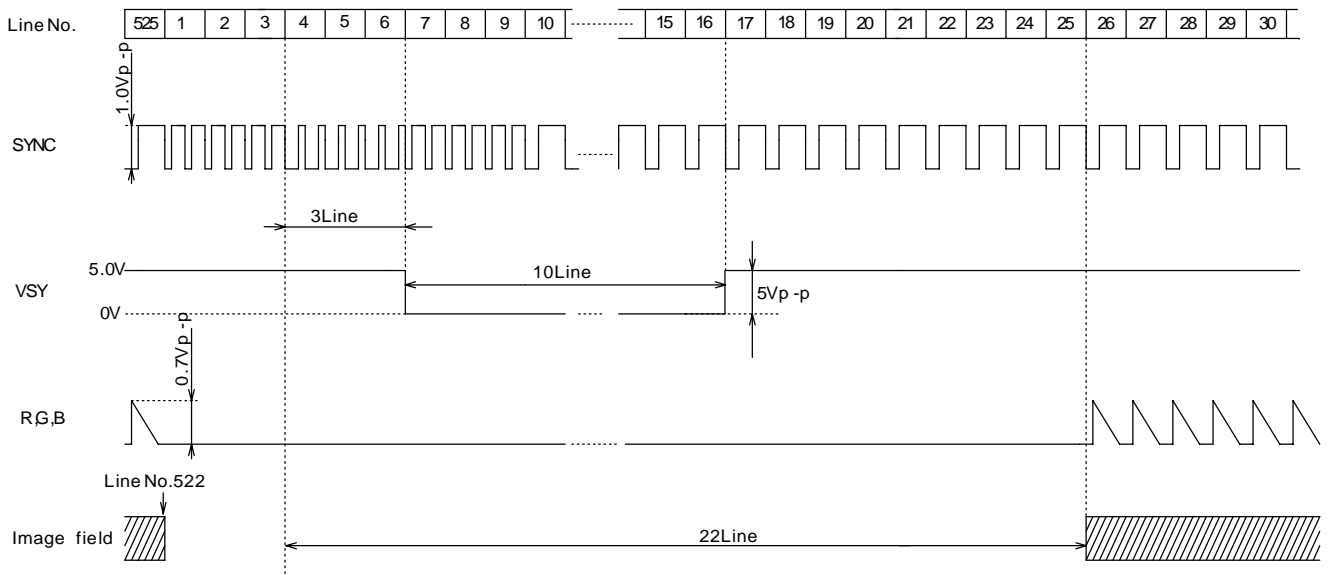

Note 1 : Display start position (of vertical) is different among display modes refer to "9. ELECTRICAL CHARACTERISTICS".

[Vertical] Analog RGB / Composite video (PAL)

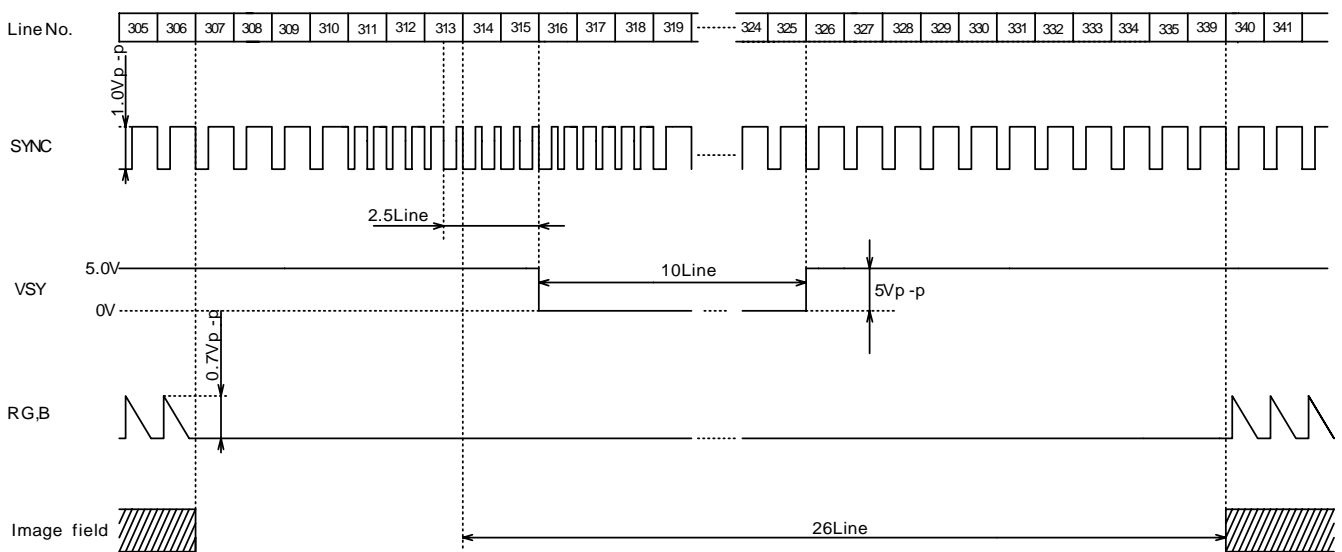
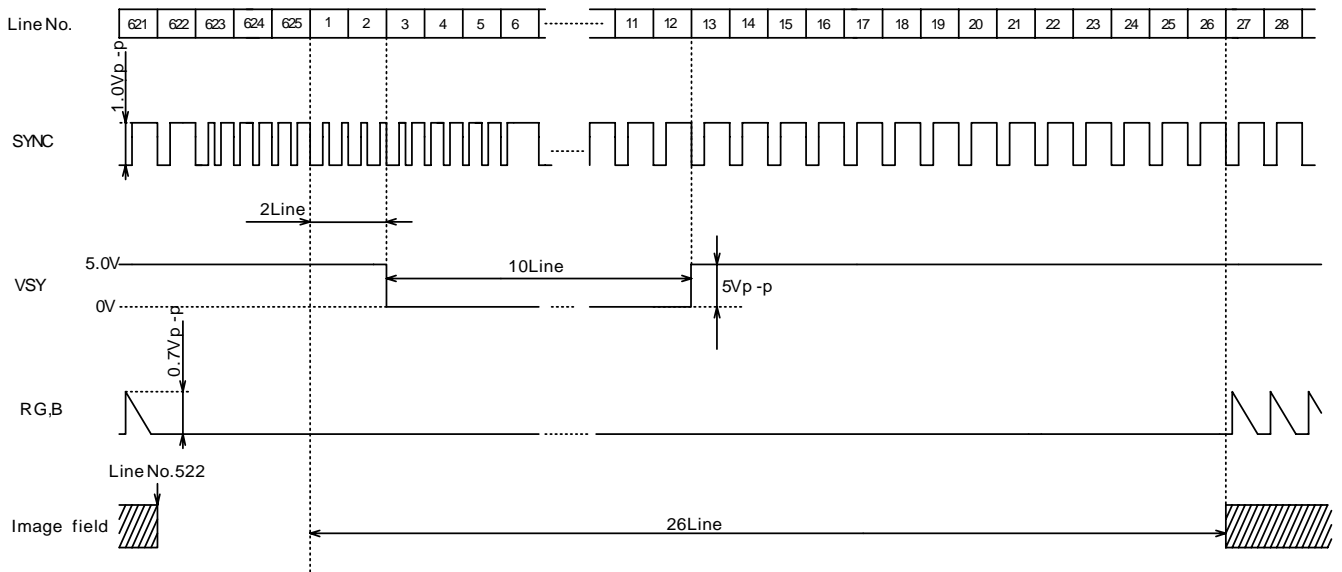

Note 1 : Display start position (of vertical) is different among display modes refer to "9. ELECTRICAL CHARACTERISTICS".

8. RECOMMENDED OPERATING CONDITIONS

(Ta=25±5°C, Vss=0V)

ITEMS	SYMBOL	CONDITONS	SPECIFICATIONS (Note 1)			UNIT	Remarks	
			MIN.	TYP.	MAX.			
SUPPLY POWER VOLTAGE	for Video Circuit	V _{CC}	-	8.5	9.0	9.5	V	Note 2
	for B/L Inverter	V _{BL}		8.5	9.0	9.5	V	Note 2
INPUT SIGNAL VOLTAGE	Composite Video	VIDEO	75Ω	-	1.0	-	V(p-p)	
	Analog RGB	R,G,B		-	0.7	-	V(p-p)	
	Composite sync.	SYNC		-	1.0	-	V(p-p)	
	Bright	BRT	V _{CC} =9.0V	-	2.5	-	V	Note 3
	Tint	TINT		-	3.0	-	V	Note 3
	Color	COLOR		-	2.5	-	V	Note 3
	B/L Dimmer Adjust	DIM		1.35	-	3.90	V	Note 3
	Signal Switch	SSW,VSW MODE 1,2,3 L/R,U/D	H Level	3.5	-	V _{DD} +0.3	V	
L Level			V _{SS} -0.3	-	1.5	V		
FRAME FREQUENCY	fVDN	NTSC	57.14	59.94	62.86	Hz		
	fHDN		15.2	15.73	16.2	kHz		
	fVDP	PAL	48.64	50.0	51.2	Hz		
	fHDP		15.20	15.63	16.00	kHz		

Note 1 : The recommended operating conditions show the ranges in which the device can operate normally. Operation beyond the limit of the recommended operating conditions is not assured, even though operating conditions are within the limit of the absolute maximum ratings.

Note 2 : Use power supplies with capacity lower than 3A.

Note 3 : Optimization of input voltage on viewing angle is necessary.

9. ELECTRICAL CHARACTERISTICS

Common Test Conditions : $T_a=25\pm 5^\circ\text{C}$, $V_{BL}=+9.0\text{V}$, $V_{CC}=+9.0\text{V}$, $V_{SS}=0\text{V}$, $BRT=2.5\text{V}$, $DIM=3.90\text{V}$,
Measured after 30 minutes operation.

ITEMS	SYMBOL	CONDITIONS	SPECIFICATIONS			UNIT	REMARKS	
			MIN.	TYP.	MAX.			
SUPPLY CURRENT	I_{CC}	$V_{CC}=9.0\text{V}$	–	185	215	mA(rms)	Note 1,2	
	I_{BL}	$V_{BL}=9.0\text{V}$	–	650	750			
OUTPUT VOLTAGE	HSY, VSY	H Level	3.5	–	V_{DD}	V		
		L Level	V_{SS}	–	1.5	V		
OUTPUT CURRENT	I_{DD}	$V_{CC}=9.0\text{V}$	–	–	10	mA(rms)	$V_{DD}=5\text{V}$	
VIDEO SIGNAL FREQUENCY	–	-3dB down	NTSC	–	2.6	–	MHz	
			PAL	–	3.0	–		
TINT ADJUST RANGE	–	NTSC	0V to 3V	–	45	–	°	Note 3
			3V to 5V	–	30	–		
COLOR ADJUST RANGE	–	COLOR (0V to 5V)	NTSC	–	4.0	–	dB	Note 4
			PAL	–	3.9	–		

Note 1 : Although protection circuit is included in this product, please add the appropriate protection circuit for this product.

Note 2 : Please input the stable composite video or composite sync.signal.Timings of HSY and VSY are not specified unless the appropriate signals are inputed.

Note 3 : Rainbow pattern.

Note 4 : Raster pattern.

DISPLAY POSITION

Common Test Conditions : $T_a=25\pm 5^\circ\text{C}$, $V_{BL}=+9.0\text{V}$, $V_{CC}=+9.0\text{V}$

[Horizontal]

Items	Symbol	Conditions	MIN.	TYP.	MAX.	Unit	Remark	
Horizontal Start Position	HPOS	NTSC	Composite	–	10.95	–	μs	Note 1
			Analog	–	10.84	–		
		PAL	Composite	–	11.66	–	μs	
			Analog	–	11.56	–		
Horizontal Display Area	HDIS	NTSC	–	50.04	–	μs		
		PAL	–	50.39	–			

Note 1 : Sampling start based on the internal horizontal sync front edge.

[Vertical]

ITEMS	SYMBOL	CONDITION	DISPLAY MODE					UNIT	REMARKS	
			Full Normal	Wide	Zoom 1	Zoom 2	Zoom 3			
Vertical Start Position	VPOS	NTSC	ODD	23	23	52	38	53	(Line)	Note 2
			EVEN	286	286	315	301	315		
		PAL	ODD	27	50	62	50	62	(Line)	
			EVEN	339	363	375	363	375		
Vertical Display Area	HDIS	NTSC	234	234	176	204	204	(Line)		
		PAL	281	234	210	234	234	(Line)		

Note 2 : Sampling start line number based on the external vertical sync.

Note 3 : Standard tolerance of Vertical position : ± 1 Line.

10. OPTICAL CHARACTERISTICS

Common Test Conditions : $T_a=25\pm 5^\circ\text{C}$, $V_{BL}=+9.0\text{V}$, $V_{CC}=+9.0\text{V}$, $V_{SS}=0\text{V}$, $BRT=2.5\text{V}$, $DIM=3.90\text{V}$,
Measured after 30 minutes operation.

ITEM	SYMBOL	CONDITIONS	SPECIFICATIONS			UNIT	REMARKS
			MIN.	TYP.	MAX.		
CONTRAST RATIO	CR	R,G,B = 0.7V/0V	40	100	–	–	Note1,2
LUMINANCE	LUM	R,G,B = 0.7V	300	350	–	cd/m ²	Note 2
VIDEO INPUT VOLTAGE –LUMINANCE	VL	R,G,B = 0V to 0.7V	Fig.1			–	
DIMMER VOLTAGE –LUMINANCE	DL	DIM = 1.35V to 3.90V	Fig.2			–	Note 2
SPECULAR REFLECTANCE RATIO	RS	–	–	1	3	%	
AFTER IMAGE	STG	–	No conspicuous pattern observed after 3 sec.			–	
BACKLIGHT LIFE (Reference)	–	DIM = 3.90V	–	10,000	–	h	Note 3,4

Note 1 : 100% brightness.

Note 2 : These values vary with brightness input.

Note 3 : MTTF(Mean Time to Failure), time to become 50% brightness.

Note 4 : Reference Value.

Fig.1 : Video Voltage – Luminance (Reference)

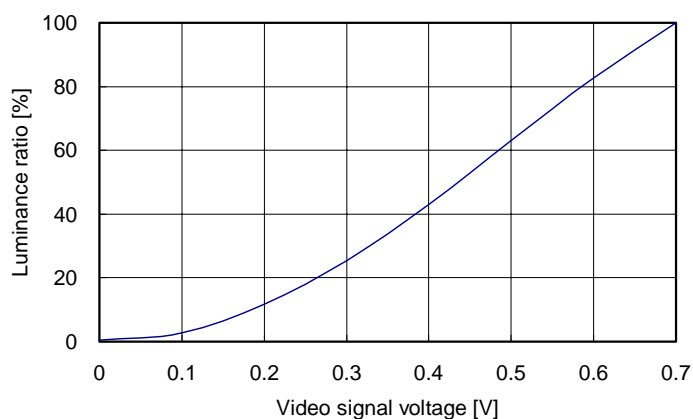
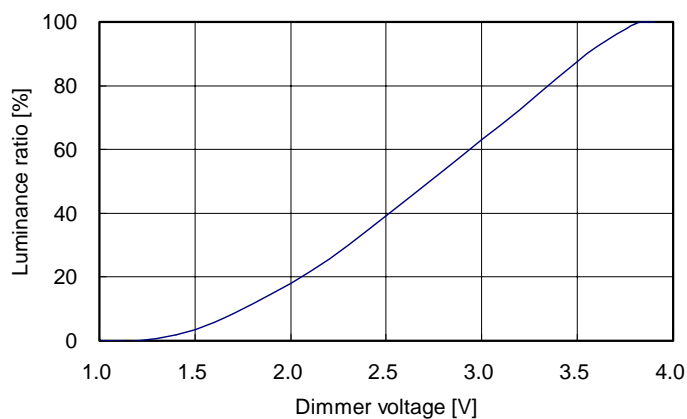

Fig.2 : Dimmer Voltage – Luminance (Reference)



11. For Safety

LCD module is generally designed with precise parts to achieve light weight and thin mechanical dimensions.

In using our Modules, make certain that you fully understand and put into practice the warnings and safety precautions detailed in Engineering Information No.EE-N001A, "CAUTIONS AND INSTRUCTIONS FOR TOSHIBA LCD MODULE".

Refer to individual specifications and TECHNICAL DATA sheets for more detailed technical information.

(1) Special Purposes

Please inform and consult Toshiba when LCD monitor is used for the equipment that relates to the safety of human body or human life.

(2) Disassembling or Modification

Do not disassemble or modify the monitor. It may damage sensitive parts inside LCD module, and may cause scratches or dust on the display.

Toshiba does not warrant the monitor, if customer disassembled or modified it.

(3) Breakage of LCD Panel

Do not ingest liquid crystal material, do not inhale this material, and do not contact the material with skin, if LCD panel is broken and liquid crystal material spills out.

If liquid crystal material comes into mouth or eyes, rinse mouth or eyes out with water immediately.

If this material contact with skin or cloths, wash it off immediately with alcohol and rinse thoroughly with water.

(4) Glass of LCD Panel

Be careful with chips of glass that may cause injuring fingers or skin, when the glass is broken.

(5) Electric Shock

Disconnect power supply before handling LCD monitor. Do not touch the parts inside LCD module in order to prevent electric shock.

(6) Absolute Maximum Ratings and Power Protection Circuit

Do not exceed the absolute maximum rating values under the worst probable conditions caused by the supply voltage variation, input voltage variation, variation in parts constants, environmental temperature, etc., otherwise LCD module may be damaged.

Suitable protection circuit should be applied for each system design.

(7) Disposal

When dispose LCD monitor, obey to the applicable environmental regulations.

(8) Power Supply Output

Be sure that power supply output from the system should be limited to smaller values than listed below.

It is because this LCD monitor explained in this data sheet has a current limiter, or a circuit with such function at power input lines, but there may be some possibility of overheat and/or burning of LCD monitor and its peripheral devices before current limiter of the monitor when open-short test of the module is performed by using higher power supply than following recommended value.

Power supply	Recommended maximum output current of power supply
V_{BL}, V_{CC} TOTAL	$\leq 3A$