

AU OPTRONICS CORPORATION

Product Specification

15.0" XGA Color TFT-LCD Module

Model Name: M150XN07 V.2

Approved by	Prepared by
<i>CC Chiu</i>	<i>TC Tsai</i>

DDBU Marketing Division / AU Optronics corporation

Customer	Checked & Approved by

Product Specification

15.0" XGA Color TFT-LCD Module
Model Name: M150XN07
V.2

Preliminary Specifications
 Final Specifications

Note: This Specification is subject to change without notice.

Contents

1.0 Handling Precautions.....	5
2.0 General Description.....	6
2.1 Display Characteristics.....	6
2.2 Optical Characteristics.....	7
3.0 Functional Block Diagram.....	12
4.0 Absolute Maximum Ratings.....	13
4.1 TFT LCD Module.....	13
4.2 Backlight Unit.....	13
4.3 Absolute Ratings of Environment.....	13
5.0 Electrical characteristics.....	14
5.1 TFT LCD Module.....	14
5.1.1 Power Specification.....	14
5.1.2 Signal Electrical Characteristics.....	15
5.2 Backlight Unit.....	16
6.0 Signal Characteristic.....	17
6.1 Pixel Format Image.....	17
6.2 The input data format.....	18
6.3 Signal Description.....	19
6.4 Interface Timing.....	20
6.4.1 Timing Characteristics.....	20
6.4.2 Timing diagram.....	21
6.5 Power ON/OFF Sequence.....	22
7.0 Connector & Pin Assignment.....	23
7.1 TFT LCD Module.....	23
7.2 Backlight Unit.....	24
7.3 Signal for Lamp connector.....	24
8.0 Reliability.....	25
9.0 Safety.....	26
9.1 Sharp Edge Requirements.....	26
9.2 Materials.....	26
9.2.1 Toxicity.....	26
9.2.2 Flammability.....	26
9.3 Capacitors.....	26
10.0 Other requirement.....	26
10.1 National Test Lab Requirement.....	26
10.2 Label.....	26

11.0 Mechanical Characteristics 27

Record of Revision

Version and Date	Page	Old description	New Description	Remark
0.1 2005/02/14	All	First Edition for Customer		

1.0 Handling Precautions

- 1) Since front polarizer is easily damaged, pay attention not to scratch it.
- 2) Be sure to turn off power supply when inserting or disconnecting from input connector.
- 3) Wipe off water drop immediately. Long contact with water may cause discoloration or spots.
- 4) When the panel surface is soiled, wipe it with absorbent cotton or other soft cloth.
- 5) Since the panel is made of glass, it may break or crack if dropped or bumped on hard surface.
- 6) Since CMOS LSI is used in this module, take care of static electricity and insure human earth when handling.
- 7) Do not open nor modify the Module Assembly.
- 8) Do not press or pat the panel surface by fingers, hand or tooling.
- 9) Do not press the reflector sheet at the back of the module to any directions.
- 10) In case if a module has to be put back into the packing container slot after once it was taken out from the container, do not press the center of the CCFL reflector edge. Instead, press at the far ends of the CCFL reflector edge softly. Otherwise the TFT module may be damaged.
- 11) At the insertion or removal of the Signal Interface Connector, be sure not to rotate nor tilt the Interface Connector of the TFT module.
- 12) After installation of the TFT module into an enclosure (Desktop monitor Bezel, for example), do not twist nor bend the TFT Module even momentary. At designing the enclosure, it should be taken into consideration that no bending/twisting forces are applied to the TFT module from outside. Otherwise the TFT module may be damaged.

2.0 General Description

This specification applies to the 15.0 inch Color TFT/LCD Module M150XN07 V2.

This module is designed for a display unit of personal computer.

The display supports the XGA (1024 (H) x 768(V)) screen format and 16.2M colors (RGB 6-bits + FRC data).

All input signals are 1 Channel LVDS interface compatible.

This module does not contain an inverter card for backlight.

2.1 Display Characteristics

The following items are characteristics summary on the table under 25 °C condition:

ITEMS	Unit	SPECIFICATIONS			
Screen Diagonal	[mm]	381 (15")			
Active Area	[mm]	304.128 (H) x 228.096			
Pixels H x V		1024(x3) x 768			
Pixel Pitch	[mm]	0.297 (per one triad) x 0.297			
Pixel Arrangement		R.G.B. Vertical Stripe			
Display Mode		TN mode, Normally White			
White Luminance	[cd/m ²]	250 (Typ) @ 8mA			
Contrast Ratio		500 : 1 (Typ)			
Optical Rise Time/Fall Time	[msec]	12 (Typ)			(Note 1)
Color Saturation		65% NTSC			
Nominal Input Voltage VDD	[Volt]	+3.3 V			
Power Consumption (VDD line + CCFL line)	[Watt]	13.3 W (Typ.) @8mA (All Black Pattern)			
Weight	[Grams]	1100 (Typ)			
Physical Size	[mm]		Min.	Typ.	Max.
		Horizatal(H)	326.0	326.5	327.0
		Vertical(V)	253.0	253.5	254.0
		Depth(D)	-	-	12.0
Electrical Interface		1 Channel LVDS			
Support Color		16.2M colors (RGB 6-bit + FRC data)			
Temperature Range					
	Operating	[°C]	0 to +50		
Storage (Shipping)	[°C]	-20 to +60			
Surface Treatment		Hard-coating (3H), anti-glare treatment			

Note 1 :System should warm up for at least one hour

2.2 Optical Characteristics

The optical characteristics are measured under stable conditions at 25 °C (Room Temperature):

Item	Unit	Conditions	Min.	Typ.	Max.	Note
Viewing Angle	[degree]	Horizontal (Right) CR = 10 (Left)	TBD	65 65		-
		Vertical (Up) CR = 10 (Down)	TBD	65 55		keep total 120(Mayb e 60,60)
		Horizontal (Right) CR = 5 (Left)	TBD	TBD		
		Vertical (Up) CR = 5 (Down)	TBD	TBD		
Contrast ratio		Normal Direction	TBD	500		-
Response Time	[msec]	Rising Time	-	TBD	TBD	Note 1
		Falling Time	-	TBD	TBD	
		Rising + Falling	-	12		
Color / Chromaticity Coordinates (CIE)		Red x	0.61	0.64	0.67	
		Red y	0.30	0.33	0.36	
		Green x	0.27	0.30	0.33	
		Green y	0.56	0.59	0.62	
		Blue x	0.12	0.15	0.18	
		Blue y	0.07	0.10	0.13	
Color Coordinates (CIE) White		White x	0.28	0.31	0.34	
		White y	0.30	0.33	0.36	
White Luminance @ CCFL 8mA (center)	[cd/m ²]		200	250		-
Luminance Uniformity	[%]		75	80		Note 2
Crosstalk (in 75Hz)	[%]			1.2	1.5	Note 3
Flicker	dB				-20	Note 4

Equipment Pattern Generator, Power Supply, Digital Voltmeter, Luminance meter (PR 880, BM-5A ,

BM 7 ,CS-1000, CA210, SR_3 & EZ Contrast(ELDIM)*)

Aperture 1° with 50cm viewing distance

Test Point Center (VESA point 9)

Environment < 1 lux

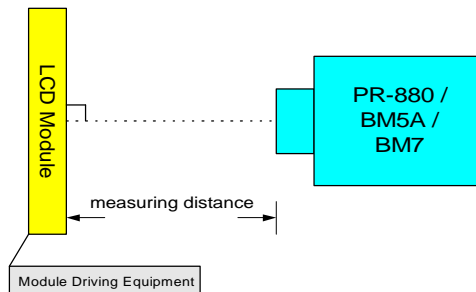

*1 EZ Contrast is different measurement tool with very close viewing distance.

Note 1: Definition of Response time

The output signals of photo detector are measured when the input signals are changed from "Black" to "White" (rising time), and from "White" to "Black" (falling time), respectively. The response time is interval between the 10% and 90% of amplitudes.

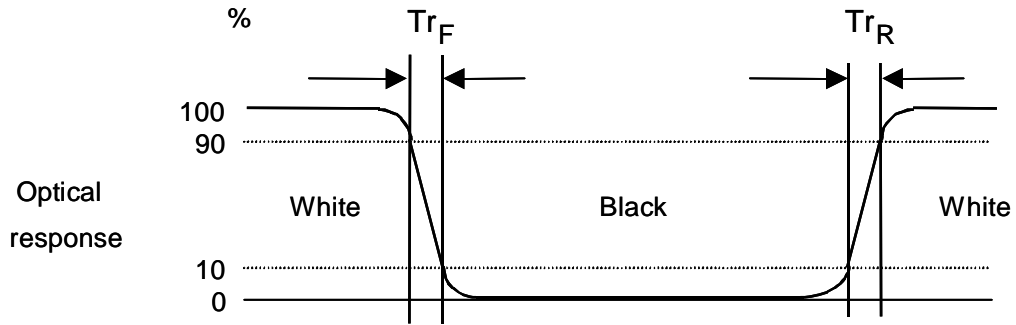

Note 2: Brightness uniformity of these 9 points is defined as below

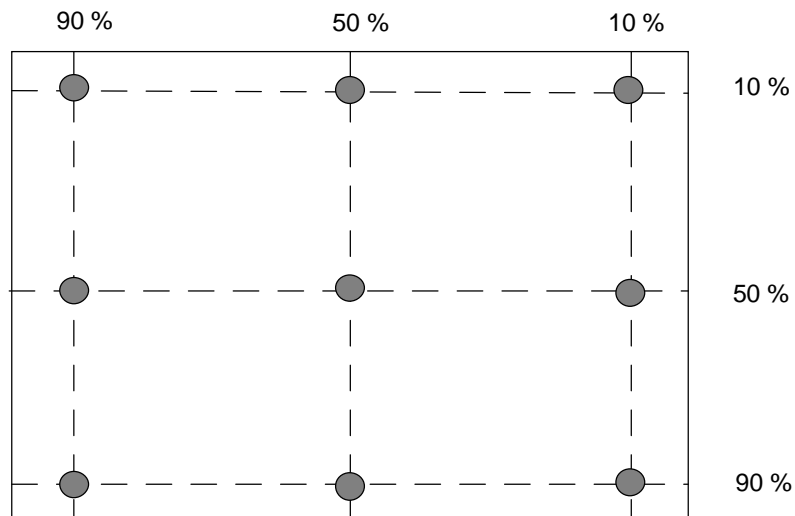

$$\text{Uniformity} = \frac{\text{Minimum Luminance in 9 points (1 - 9)}}{\text{Maximum Luminance in 9 Points (1 - 9)}} \times 100\%$$

Note 3: Crosstalk is defined as below :

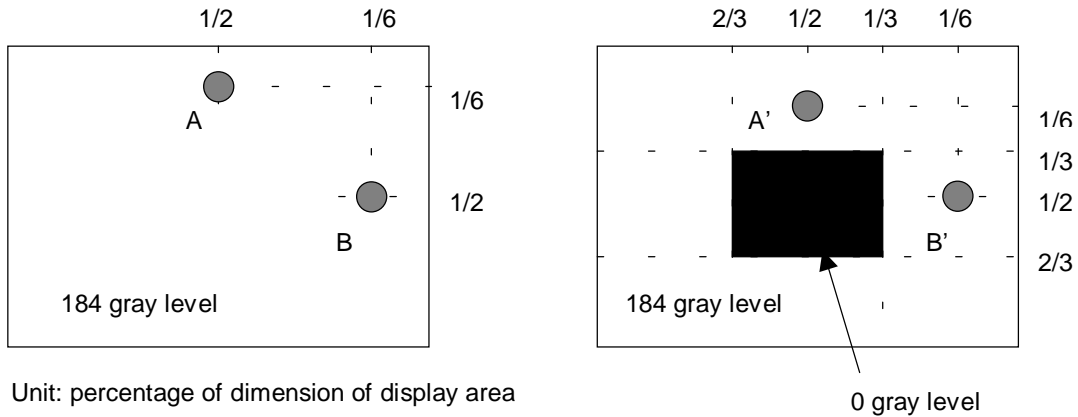

Unit: percentage of dimension of display area

$|L_A - L_{A'}| / L_A \times 100\% = 1.5\% \text{ max.}$, L_A and L_B are brightness at location A and B

$|L_B - L_{B'}| / L_B \times 100\% = 1.5\% \text{ max.}$, $L_{A'}$ and $L_{B'}$ are brightness at location A' and B'

Note 4: Test Patern: Subchecker Pattern at 127 gray level

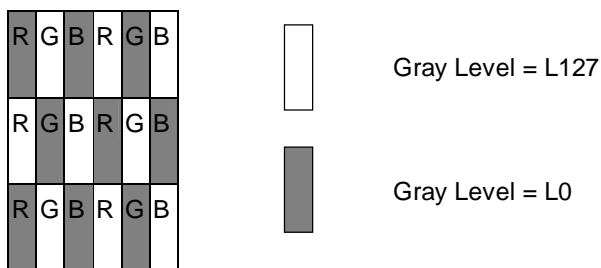
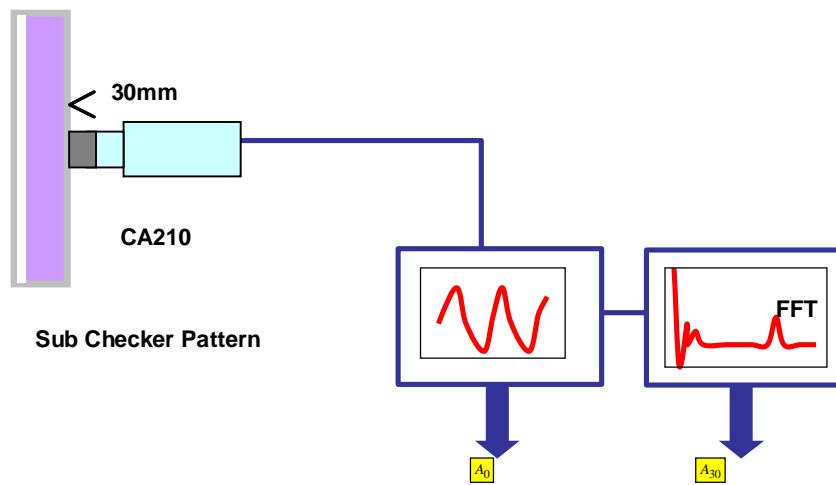

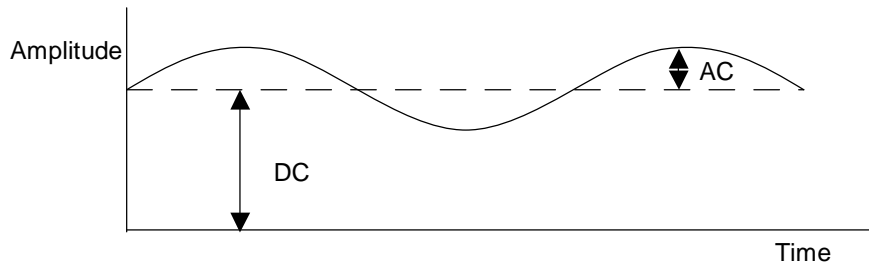

$$\text{Flicker (dB)} = 20 \log \frac{\text{AC Level(at 30 Hz)}}{\text{DC Level}}$$

4.0 Absolute Maximum Ratings

Absolute maximum ratings of the module is as following:

4.1 TFT LCD Module

Item	Symbol	Min	Max	Unit	Conditions
Logic/LCD Drive	VDD	0.3	+3.6	[Volt]	Note 1,2

4.2 Backlight Unit

Item	Symbol	Min	Max	Unit	Conditions
CCFL Current	IRCFL	-	8.5	[mA] rms	Note 1,2

4.3 Absolute Ratings of Environment

Item	Symbol	Min	Max	Unit	Conditions
Operating Temperature	TOP	0	+50	[°C]	Note 3
Operating Humidity	HOP	8	90	[%RH]	Note 3
Storage Temperature	TST	-20	+60	[°C]	Note 3
Storage Humidity	HST	8	90	[%RH]	Note 3

Note 1: With in Ta (25°C)

Note 2: Permanent damage to the device may occur if exceed maximum values

Note 3: For quality performance, please refer to AUO IIS(Incoming Inspection Standard) . Please refer the graph below for the corresponding of temperature and humidity."

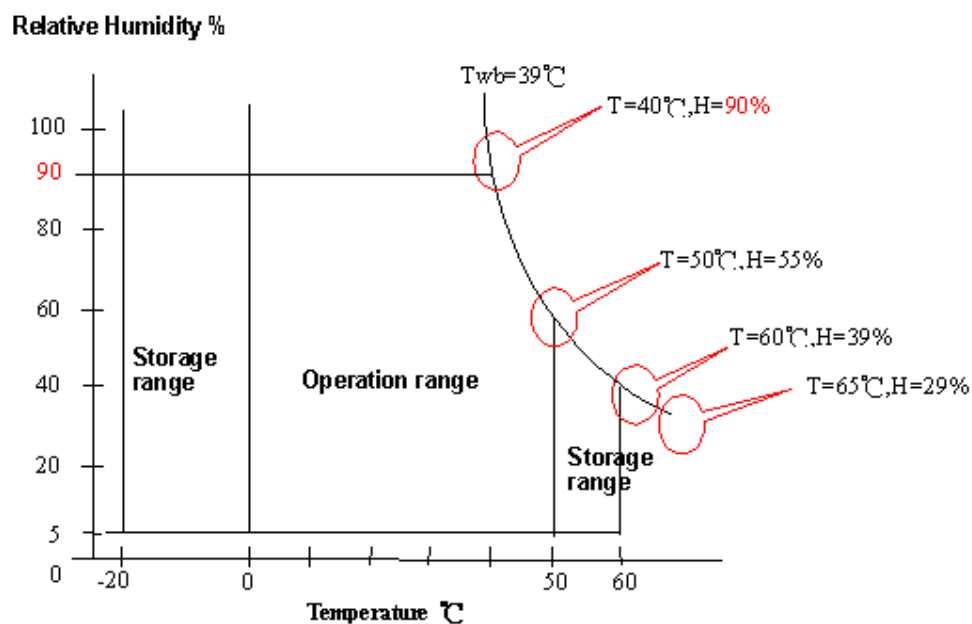

5.0 Electrical characteristics

5.1 TFT LCD Module

5.1.1 Power Specification

Input power specifications are as follows;

Symbol	Parameter	Min	Typ	Max	Units	Condition
VDD	Logic/LCD Drive Voltage	3.0	3.3	3.6	[Volt]	± 10%
IDD	VDD current	-	600	700	[mA]	Vin=3.3V , Gray Bar Pattern, at 60Hz
Irush	LCD Inrush Current	-	-	3	[A]	Note
PDD	VDD Power		2.0	2.3	[Watt]	Vin=3.3V , Gray Bar Pattern, at 60Hz
VDDrp	Allowable Logic/LCD Drive Ripple Voltage			100	[mV] p-p	Vin=3.3V , All Black Pattern, at 75Hz

Note: Measurement conditions:

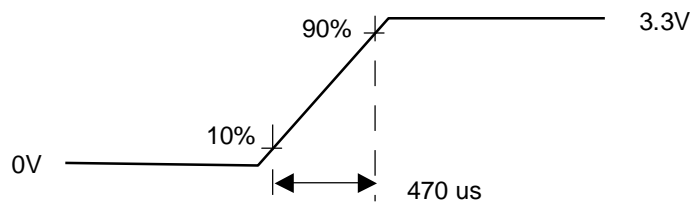
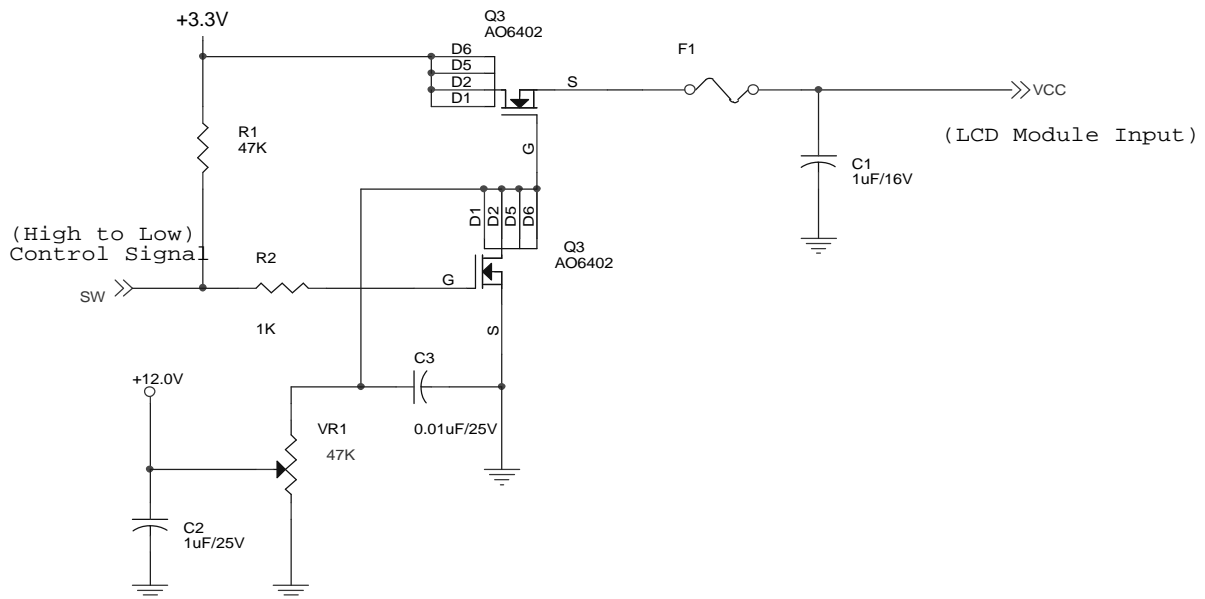

Vin rising time

5.1.2 Signal Electrical Characteristics

Input signals shall be low or Hi-Z state when V_{in} is off

It is recommended to refer the specifications of SN75LVDS82DGG (Texas Instruments) in detail.

Each signal characteristics are as follows;

Symbol	Parameter	Min	Typ	Max	Units	Condition	
VTH	Differential Input High Threshold	-	-	100	[mV]	$V_{ICM} = 1.2V$	Note
VTL	Differential Input Low Threshold	-100	-	-	[mV]	$V_{ICM} = 1.2V$	Note
VID	Input Differential Voltage	100	400	600	[mV]		Note
VICM	Differential Input Common Mode Voltage	1.1	-	1.45	[V]	$V_{TH}/V_{TL} = \pm 100mV$	Note

Note: LVDS Signal Waveform

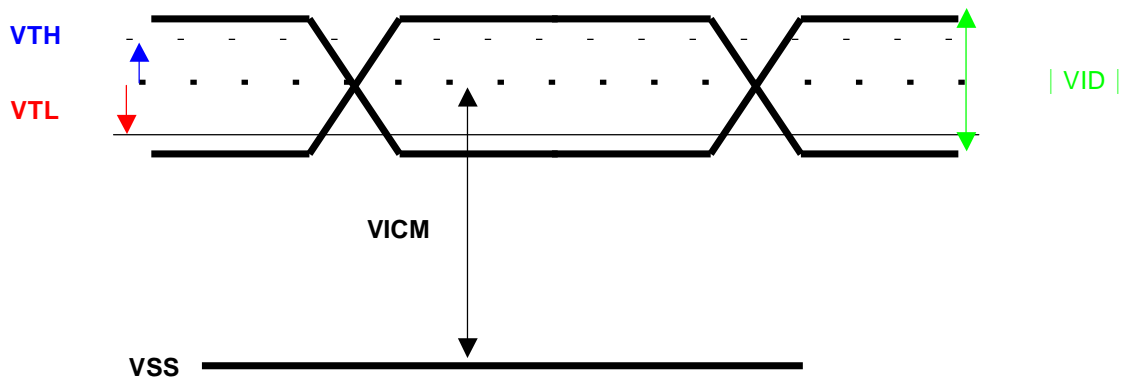

5.2 Backlight Unit

Parameter guideline for CCFL Inverter

Symbol	Parameter	Min.	Typ.	Max.	Unit	Condition
IRCFL	CCFL operation range	2.5	8	8.5	[mA] rms	(Ta=25°C) Note 4
ICFL	CCFL Inrush current	-	-	20	[mA]	
FCFL	CCFL Frequency	40	55	80	[KHz]	(Ta=25°C) Note 1
ViCFL (0°C) (reference)	CCFL Ignition Voltage	1450	-	-	[Volt] rms	(Ta=0°C) Note 3
ViCF (25°C) (reference)	CCFL Ignition Voltage	1100	-	-	[Volt] rms	(Ta=25°C) Note 3
VCFL	CCFL Discharge Voltage	-	620 (@8mA)	710 (@2.5mA)	[Volt] rms	(Ta=25°C) Note 2
PCFL	CCFL Power consumption @8mA(excluding inverter)	-	10	11	[Watt]	(Ta=25°C) Note 2

Note 1: CCFL frequency should be carefully determined to avoid interference between inverter and TFT LCD.

Note 2: Calculator value for reference (IRCFLxVCFLx2=PCFL).

Note 3: CCFL inverter should be able to give output a voltage more than 1450 volt. Lamp units need 1450 volt minimum for ignition.

Note 4: CCFL life time is 30,000hr at 8.0mA, it's defined as when the brightness is reduced by half. It's recommended not to exceed 8.0mA for CCFL life time concern and it's prohibited to exceed 8.5mA for safety concern.

6.0 Signal Characteristic

6.1 Pixel Format Image

Following figure shows the relationship of the input signals and LCD pixel format.

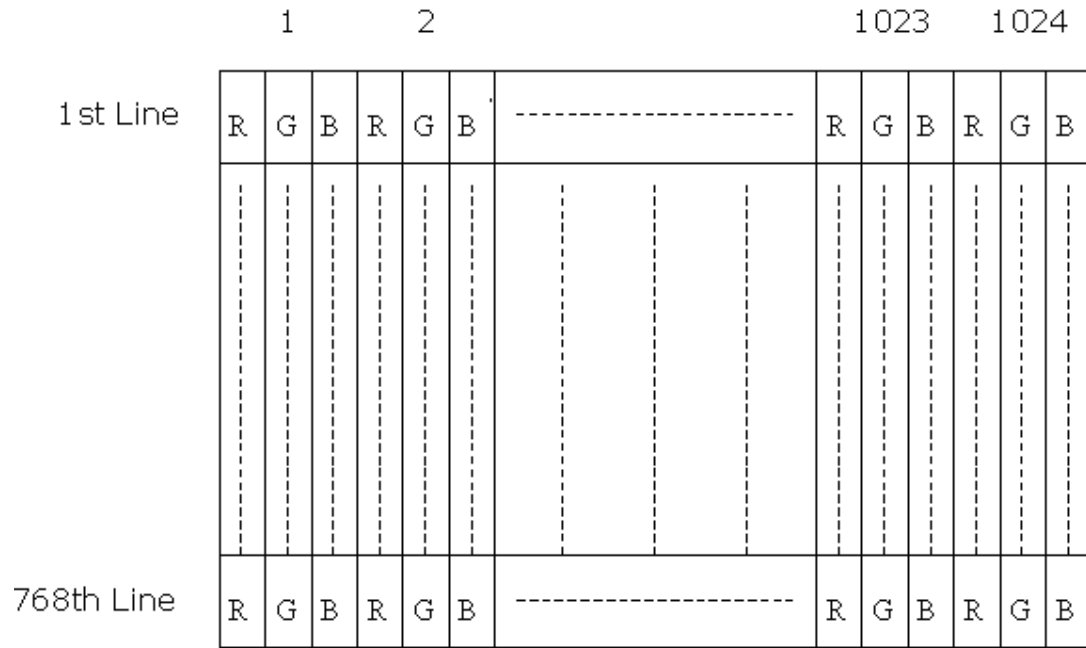

6.2 The input data format

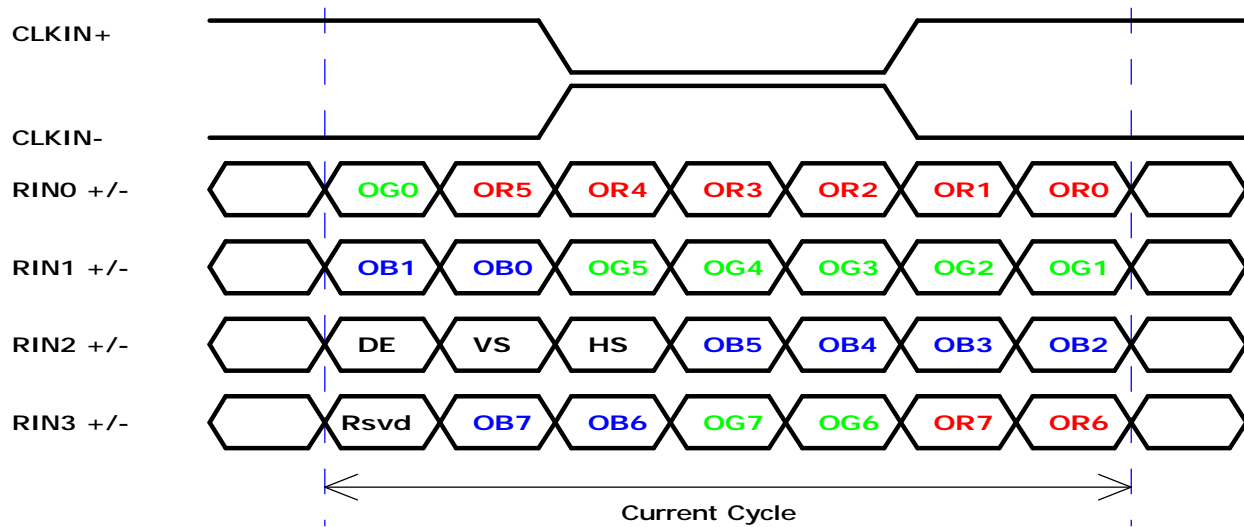

Note1: Please follow PSWG.

Note2: 8-bit in

Note3: R/G/B data 7:MSB, R/G/B data 0:LSB

6.3 Signal Description

The module using a pair of LVDS receiver SN75LVDS82(Texas Instruments) or compatible. LVDS is a differential signal technology for LCD interface and high speed data transfer device. Transmitter shall be SN75LVDS83(negative edge sampling) or compatible. The first LVDS port(RxOxxx) transmits odd pixels while the second LVDS port(RxExxx) transmits even pixels.

CWY20G-A0D1T (PTWO) or MSB240420 (STM)		
Pin No.	Symbol	Description
1	VDD	Power Supply, 3.3V (typical)
2	VDD	Power Supply, 3.3V (typical)
3	VSS	Ground
4	VSS	Ground
5	Rin0-	- LVDS differential data input (R0-R5, G0)
6	Rin0+	+ LVDS differential data input (R0-R5, G0)
7	VSS	Ground
8	Rin1-	- LVDS differential data input (G1-G5, B0-B1)
9	Rin1+	+ LVDS differential data input (G1-G5, B0-B1)
10	VSS	Ground
11	Rin2-	- LVDS differential data input (B2-B5, HS, VS, DE)
12	Rin2+	+ LVDS differential data input (B2-B5, HS, VS, DE)
13	VSS	Ground
14	ClkIN-	- LVDS differential clock input
15	ClkIN+	+ LVDS differential clock input
16	VSS	Ground
17	Rin3-	- LVDS differential data input (R6-R7, G6-G7,B6-B7)
18	Rin3+	- LVDS differential data input (R6-R7, G6-G7,B6-B7)
19	VSS	Ground
20	VSS	Ground

Note: Please follow PSWG.

6.4 Interface Timing

6.4.1 Timing Characteristics

Basically, interface timings described here is not actual input timing of LCD module but output timing of SN75LVDS82DGG (Texas Instruments) or equivalent.

Signal	Parameter	Symbol	MIN	TYP	MAX	Unit
Clock Timing	Clock frequency	clk	50	65	81	MHz
Hsync Timing	Horizontal active	Thd	1024	1024	1024	Tclk
	Horizontal blanking	Thbl	40	320	400	Tclk
	Horizontal period	Th	1064	1344	1424	Tck
Vsync Timing	Vertical active	Tvd	768	768	768	Th
	Vertical blanking	Tvbl	8	38	75	Th
	Vertical period	Tv	776	806	843	Th

Note:DE mode only

Note: Typical value refer to VESA STANDARD

6.4.2 Timing diagram

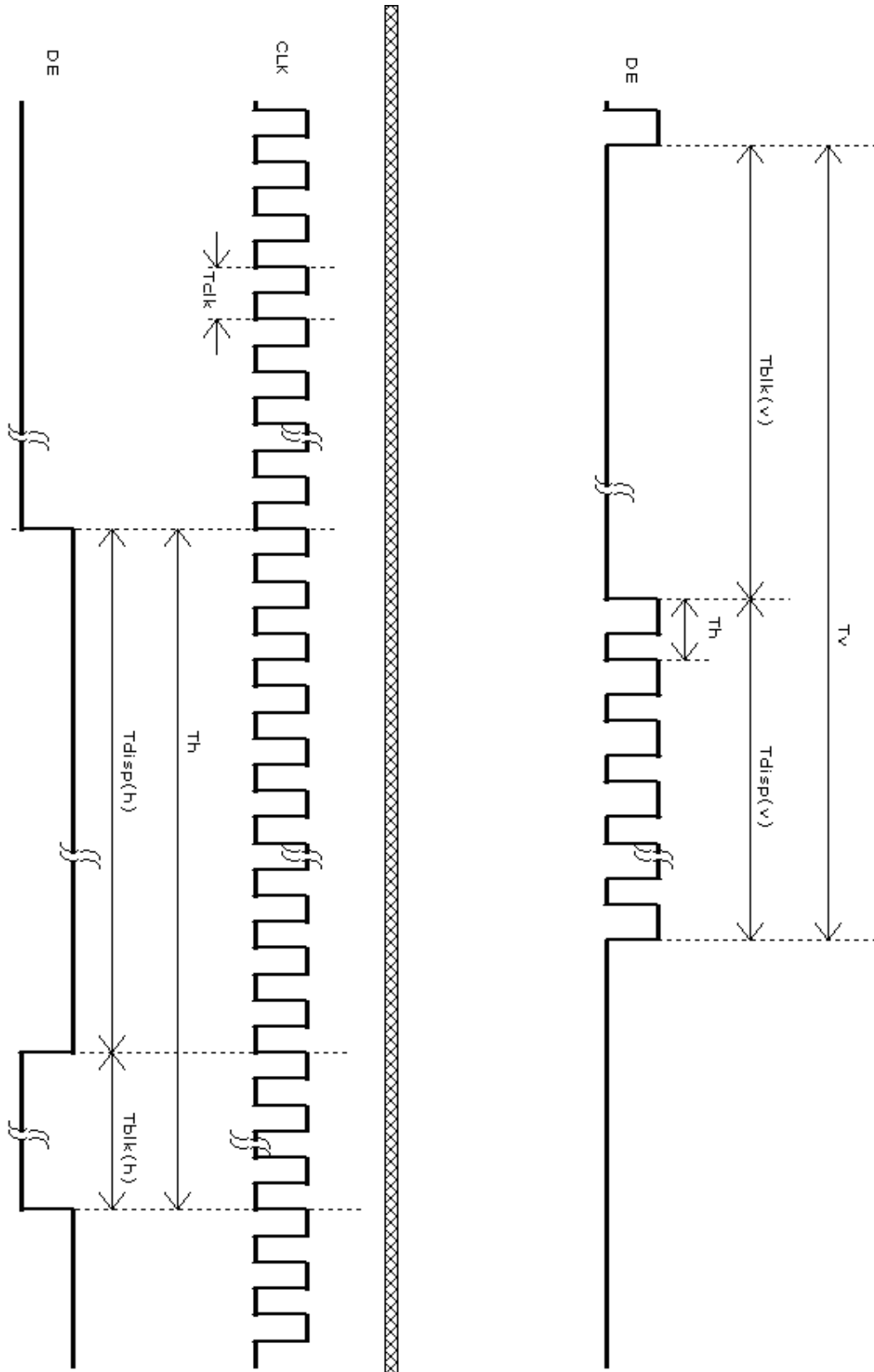

6.5 Power ON/OFF Sequence

Vin power and lamp on/off sequence is as follows. Interface signals are also shown in the chart. Signals from any system shall be Hi-Z state or low level when Vin is off.

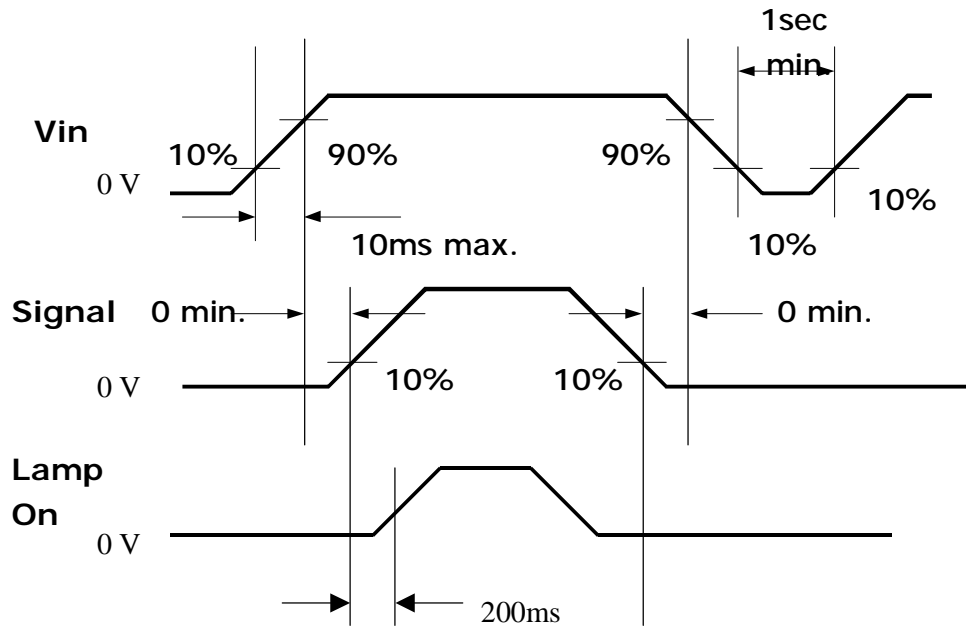

7.0 Connector & Pin Assignment

Physical interface is described as for the connector on module.

These connectors are capable of accommodating the following signals and will be following components.

7.1 TFT LCD Module

Connector Name / Designation	Interface Connector / Interface card
Manufacturer	P-TWO or compatible
Type Part Number	CWY20G – A0G16 / MSB240420
Mating Housing Part Number	HRS DF14-20S-1.25C

Pin#	Signal Name	Pin#	Signal Name
1	VDD	2	VDD
3	VSS	4	VSS
5	Rin0-	6	Rin0+
7	VSS	8	Rin1-
9	Rin1+	10	VSS
11	Rin2-	12	Rin2+
13	VSS	14	ClkIN-
15	ClkIN+	16	VSS
17	Rin3-	18	Rin3+
19	VSS	20	VSS

7.2 Backlight Unit

Connector Name / Designation	For Lamp Connector
Manufacturer	JST or compatible
Type / Part Number	BHR-03VS-1
Mating Type / Part Number	SM02(8.0)B-BHS-1-TB

7.3 Signal for Lamp connector

Pin	Symbol	Description
1	HV	Lamp High Voltage
2	NC	No connection
3	LV	Ground

- ⌌ Cable length: 140 +- 5 mm
- ⌌ Connector-output position: right side (front view)
- ⌌ Lamp assembly design shall be easy for replacement and repair.

8.0 Reliability

Reliability test condition

No	Test Item	Test Condition
1	Temperature Humidity Bias (THB)	50°C , 80% , 300hours
2	High Temperature Operation (HTO)	50°C , 300hours
3	Low Temperature Operation (LTO)	0°C , 300hours
4	High Temperature Storage (HTS)	60°C , 300hours
5	Low Temperature Storage (LTS)	-20°C , 300hours
6	Thermal Shock Test (TST)	-20°C/30min, 60°C/30min, 100 cycles
7	On/Off Test	On/10sec, Off/10sec, 30,000 cycles
8	Shock Test (Non-Operating)	50G, 20ms, Half-sine wave ($\pm X$, $\pm Y$, $\pm Z$)
9	Vibration Test (Non-Operating)	1.5G(10~200Hz P- P), 30 Minutes each Axis (X, Y, Z)
10	ESD (ElectroStatic Discharge)	Contact Discharge: $\pm 8KV$, 150pF(330 Ω) 1sec, 8 points, 25 times/ point Air Discharge: $\pm 15KV$, 150pF(330 Ω) 1sec, 8 points, 25 times/ point
11	Altitude Test	Operation:10,000 ft Non-Operation:30,000 ft
12	Drop Test	The drop height is 60cm

9.0 Safety

9.1 Sharp Edge Requirements

There will be no sharp edges or comers on the display assembly that could cause injury.

9.2 Materials

9.2.1 Toxicity

There will be no carcinogenic materials used anywhere in the display module. If toxic materials are used, they will be reviewed and approved by the responsible AUO Toxicologist.

9.2.2 Flammability

All components including electrical components that do not meet the flammability grade UL94-V1 in the module will complete the flammability rating exception approval process.

The printed circuit board will be made from material rated 94-V1 or better. The actual UL flammability rating will be printed on the printed circuit board.

9.3 Capacitors

If any polarized capacitors are used in the display assembly, provisions will be made to keep them from being inserted backwards.

10.0 Other requirement

10.1 National Test Lab Requirement

The display module will satisfy all requirements for compliance to

UL 1950, First Edition	U.S.A. Information Technology Equipment
CSA C22.2 No.950-M89	Canada, Information Technology Equipment
EEC 950	International, Information Technology Equipment
EN 60 950	International, Information Processing Equipment (European Norm for IEC950)

10.2 Label

The label is on the panel as shown below:

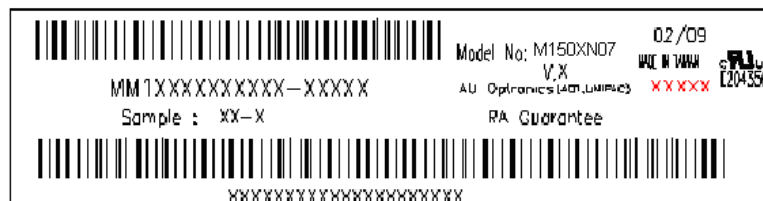

11.0 Mechanical Characteristics

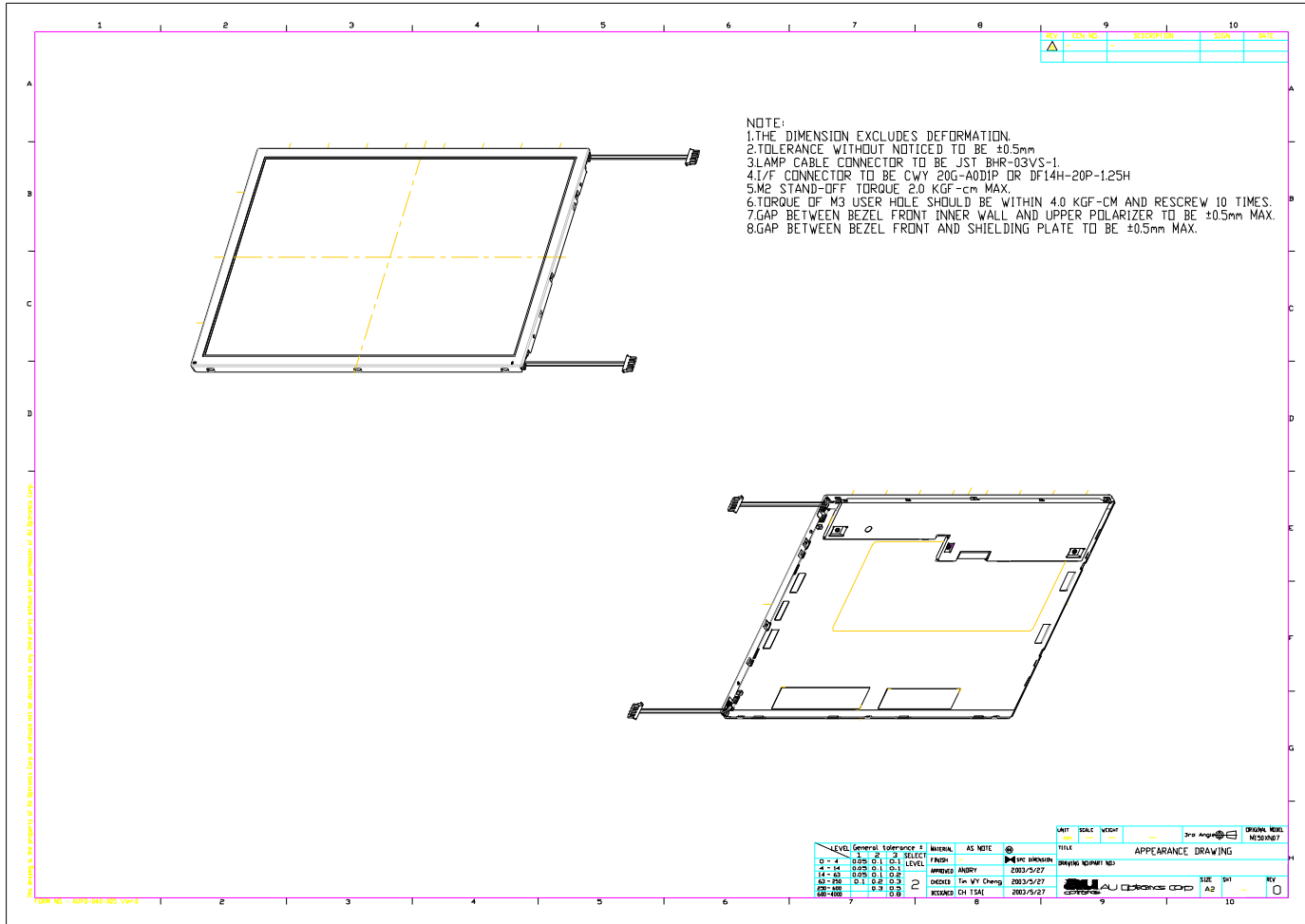

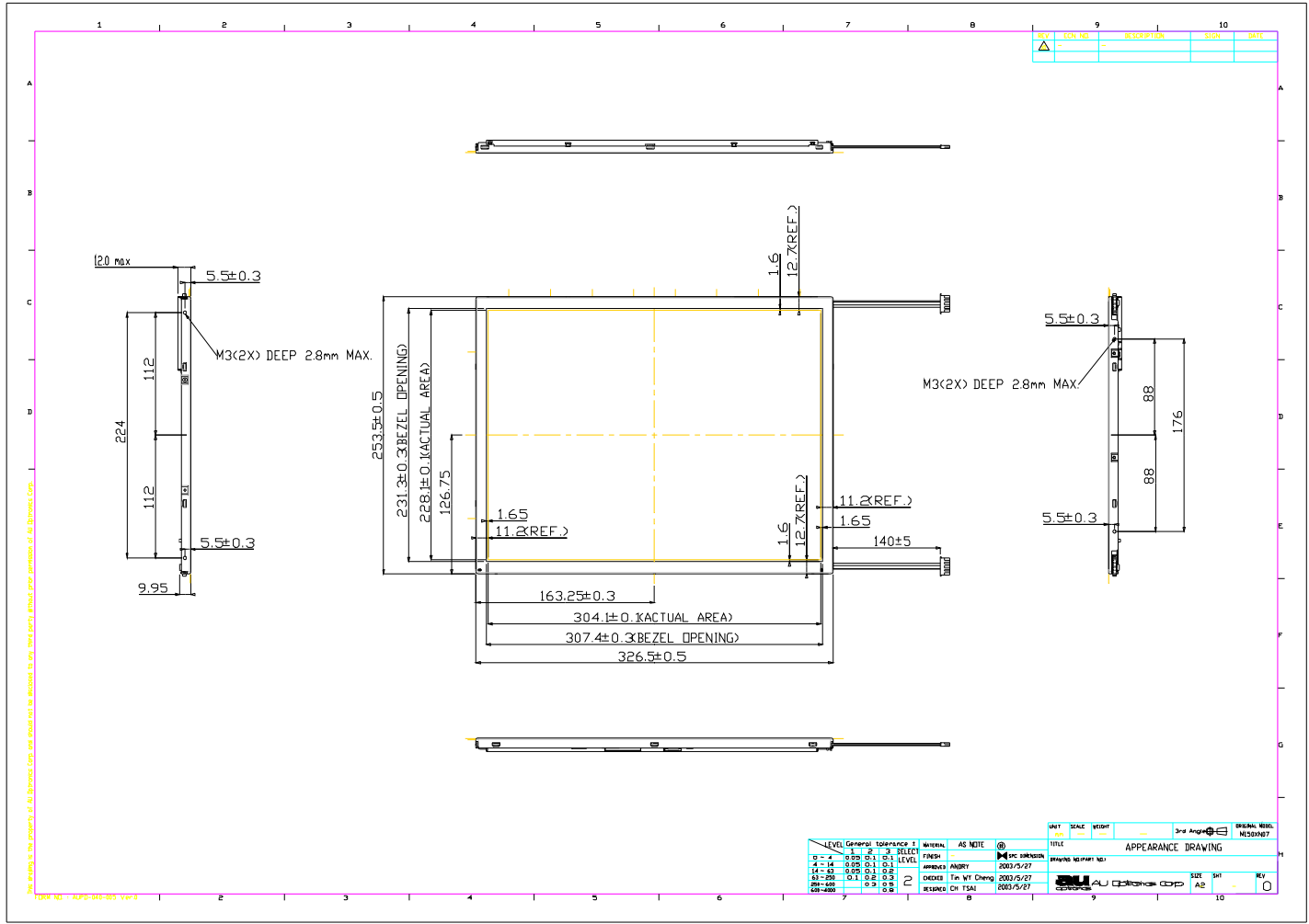

NO.	CON. NO.	DESCRIPTION	SIGN.	DATE
1				

LEVEL	GENERAL	REFERENCE	MINOR	AS NOTE	TITLE
0	0.00	0.00	0.00	0.00	APPEARANCE DRAWING
1	0.05	0.05	0.05	0.05	
2	0.10	0.10	0.10	0.10	
3	0.15	0.15	0.15	0.15	
4	0.20	0.20	0.20	0.20	
5	0.25	0.25	0.25	0.25	
6	0.30	0.30	0.30	0.30	
7	0.35	0.35	0.35	0.35	

DATE	SCALE	REVISION	DRW. ANGLE	SHEET NO.	TOTAL SHEETS
2003/5/27				1	1

NO.	DATE	BY	CHECKED	DATE
1	2003/5/27	CHEN, CHIAU	CHEN, CHIAU	2003/5/27

