

PREPARED BY : DATE 	<h1 style="margin: 0;">S H A R P</h1> <p style="margin: 5px 0;">TENRI LIQUID CRYSTAL DISPLAY GROUP SHARP CORPORATION</p> <h2 style="margin: 0;">SPECIFICATION</h2>	SPEC No. LD-7606A
APPROVED BY : DATE 		FILE No.
		ISSUE : March. 8.1996
		PAGE : 18 pages
		APPLICABLE GROUP Tenri Liquid Crystal Display Group

DEVICE SPECIFICATION FOR

TFT-LCD Module

MODEL No.

LQ14D412

www.millotech.com

•1 CUSTOMER' S APPROVAL

DATE _____

BY _____

PRESENTED
 BY *H. Fukuoka*
 H. FUKUOKA
 Department General Manager
 Engineering Department 2
 TFT LCD Development Center
 TENRI LIQUID CRYSTAL DISPLAY GROUP
 SHARP CORPORATION

1. Application

This specification applies to color TFT-LCD module, LQ14D412.

2. Overview

This module is a color active matrix LCD module incorporating amorphous silicon TFT (Thin Film Transistor). It is composed of a color TFT-LCD panel, driver ICs, control circuit, power supply circuit and a backlight unit (including a DC/AC inverter). Graphics and texts can be displayed on a 640X3X480 dots panel with 16M colors by supplying 24 bit data signal (8bit/color), four timing signals, +5V DC supply voltage for TFT-LCD panel driving and supply voltage for a backlight-driving DC/AC inverter.

The TFT-LCD panel used for this module is a low-reflection and higher-color-saturation type. Therefore, this module is suitable for the computer display and the multimedia use.

Optimum viewing direction is 6 o'clock.

3. Mechanical Specifications

Parameter	Specifications	unit
Display size	35 (13.8") Diagonal	cm
Active area	281.3(H) X 207.8(V)	mm
Pixel format	640(H) X 480(V)	pixel
	(1 pixel = R + G + B dots)	
Pixel pitch	0.44 (H) X 0.43 (V)	mm
Pixel configuration	R,G,B vertical stripe	
Display mode	Normally white	
Unit outline dimensions *1	330 (W) X 242 (H) X 18 (D)	mm
Mass	1400±50	g
Surface treatment	Anti-glare and hard-coating 2H (Haze value = 6)	

*1. Note: excluding backlight cables.

Outline dimensions is shown in Fig. 1

4. Input Terminals

4-1. TFT-LCD panel driving

CN1 Used connector: AXN440330* (Matsushita Electric Works)
 Corresponding connector: AXN340038* (Matsushita Electric Works)
 * gold plated connector

Pin No.	Symbol	Function	Remark
1	Vcc	+5 V Supply Voltage	
2	Vcc	+5 V Supply Voltage	
3	Vcc	+5 V Supply Voltage	
4	CK	Clock signal for sampling each data signal	
5	GND		
6	GND		
7	Hsync	Horizontal synchronous signal	[Note1]
8	Vsync	Vertical synchronous signal	[Note1]
9	ENAB	Data Enable signal	[Note2]
10	GND		
11	GND		
12	R0	RED data signal (LSB)	
13	R1	RED data signal	
14	R2	RED data signal	
15	R3	RED data signal	
16	R4	RED data signal	
17	R5	RED data signal	
18	R6	RED data signal	
19	R7	RED data signal (MSB)	
20	GND		
21	GND		
22	G0	GREEN data signal (LSB)	
23	G1	GREEN data signal	
24	G2	GREEN data signal	
25	G3	GREEN data signal	
26	G4	GREEN data signal	
27	G5	GREEN data signal	
28	G6	GREEN data signal	
29	G7	GREEN data signal (MSB)	
30	GND		
31	GND		
32	B0	BLUE data signal (LSB)	
33	B1	BLUE data signal	
34	B2	BLUE data signal	
35	B3	BLUE data signal	
36	B4	BLUE data signal	
37	B5	BLUE data signal	
38	B6	BLUE data signal	
39	B7	BLUE data signal (MSB)	
40	GND		

※The shielding case is connected with signal GND.

[Note 1] The 480 line mode, the 400 line mode or the 350 line mode is selected by the polarity combination of sync signals.

Mode	Hsync Polarity	Vsync Polarity
480 lines	Negative	Negative
400 lines	Negative	Positive
350 lines	Positive	Negative

[Note 2] The horizontal display start position is settled in accordance with a rising edge of **ENAB** signal. In case **ENAB** is fixed "Low" or "High", the horizontal start position is determined as described in 7-2.

4-2. Backlight driving

CN2 Used connector: S5E-PH-SM (JST) o r S5E-PH-SM3 (JST)
 Corresponding comector: PHR-5 (JST)

Pin no.	Symbol	I/O	Function	Remark
1	V _{DD}	I	+12V Supply Voltage	[Note 1]
2	GND			
3	V _{CON}	I	Luminance Control Voltage	
4	V _{ST}	O	Lamp Status Signal	[Note 2]
5	V _{EE}	I	+5V Supply Voltage	[Note 1]

[Note 1] The time of V_{EE} is at the same time or later than that of V_{DD}.

Power Sequence of inverter

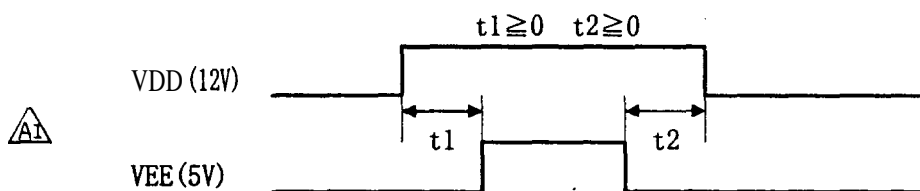

There is no relation between above and Vcon timing.

[Note 2] 5V:lit on or normally, 0V:lit off or abnormally

5. Absolute Maximum Ratings

Parameter	symbol	Condition	Ratings	unit	Remark
Signal Input voltage	V_I	$T_a=25^\circ\text{C}$	$-0.3 \sim V_{CC}+0.3$	V	【Note1】
+5V supply voltage	V_{CC}	$T_a=25^\circ\text{C}$	$0 \sim +6$	V	
+5V supply voltage	V_{EE}	$T_a=25^\circ\text{C}$	$0 \sim +7$	V	
+12V supply voltage	V_{DD}	$T_a=25^\circ\text{C}$	$0 \sim +20$	V	
Luminance Control Voltage	V_{CON}	$T_a=25^\circ\text{C}$	$0 \sim +7$	V	
Storage temperature	T_{stg}	-	$-25 \sim +60$	$^\circ\text{C}$	【Note2】
Operating temperature (Ambient)	T_{opa}	-	$0 \sim +50$	$^\circ\text{C}$	

【Note1】 CK, R0~R7, G0~G7, B0~B7, Hsync, Vsync, ENAB

【Note2】 Humidity : 95%RH Max. at $T_a \leq 40^\circ\text{C}$.

Maximum wet-bulb temperature at 39°C or less at $T_a > 40^\circ\text{C}$.

No condensation.

6. Electrical Characteristics

6-1. TFT-LCD panel driving

$T_a=25^\circ\text{C}$

Parameter	symbol	Min.	Typ.	Max.	unit	Remark	
+ 5V	Supply voltage	V_{CC}	+4.5	+5.0	+5.5	v	【Note1】
	Current dissipation	I_{CC}	-	350	700	m A	【Note2】
Permissible input ripple voltage	V_{RF}	-	-	100	mV _{pp}	$V_{CC}=+5V$	
Input voltage (Low)	V_{IL}	-	-	$0.3V_{CC}$	v	【Note3】	
Input voltage (High)	V_{IH}	$0.7V_{CC}$	-	-	v		
Input current (low)	I_{OL}	-	-	10	μA	$V_I=0V$ 【Note3】	
Input current (High)	I_{OH1}	-	-	10	μA	$V_I=V_{CC}$ 【Note4】	
	I_{OH2}	-	-	100	μA	$V_I=V_{CC}$ 【Note5】	

【Note1】
Vcc-turn-on conditions

- $0 < t1 \leq 10ms$
- $0 < t2 \leq 10ms$
- $0 < t3 \leq 1s$

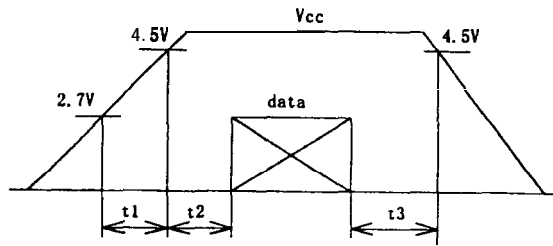

Vcc-dip conditions

- 1) $2.7V \leq Vcc < 4.5V$
 $td \leq 10ms$
- 2) $Vcc < 2.7V$

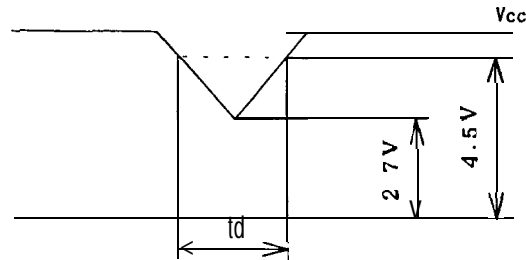

Vcc-dip conditions should also follow the Vcc-turn-on conditions

$toff > 1s$

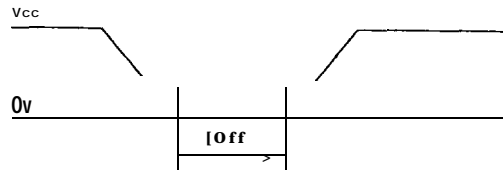

【Note2】 Typical current situation : 16-gray-bar pattern.

480 line mode

Vcc=+5.0V

【Note3】 CK,R0~R7,G0~G7,B0~B7,Hsync,Vsync,ENAB

【Note4】 CK,R0~R7,G0~G7,B0~B7,Hsync, Vsync

【Note5】 ENAB

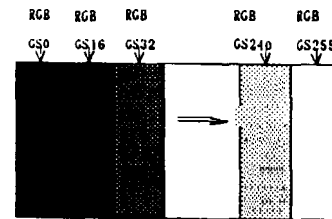

6-2. Backlight driving

The backlight system is an edge-lighting type with double CCFT (Cold Cathode Fluorescent Tube). The characteristics of lamps are shown in the following table.

Ta=25°C

Parameter	Symbol	Min.	Typ	Max.	Unit	Remark
+12V Supply Voltage	VDD	10.8	12.0	13.2	v	
+12V Supply Current	IDD	-	700	900	mA	VDD = 12.0V
+5V Supply Voltage	VEE	4.75	5.0	5.25	v	
+5V Supply Current	IEE	-	3.3	5.0	mA	
Bright Control Voltage	VCON	0	-	3.5	V	【Note1】
Lamp OFF Voltage	VCON	4.5	-	5.0	v	
Bright Control Current	ICON	-	-	1.0	mA	
Lamp Status Voltage (Lamp ON)	VST	VEE -0.5	VEE	-	v	【Note2】
Lamp status voltage (Lamp OFF)	VST	0	-	0.5	v	
Lamp life time	LL	10000	-	-	H	【Note3】
Permissible input ripple voltage	VDD	V _{R(DD)}	-	150	mVp-p	【Note4】
	VEE	V _{R(EE)}	-	100	mVp-p	
	Vcon	V _{R(con)}	-	100	mVp-p	



【Note1】 $V_{CON} = OV$: Luminance Max.
 $V_{CON} = 3.5V$: Luminance Min.

【Note2】 In case of V_{DD}, V_{EE}, V_{COM} are used out of recommended operating conditions, this Status may not properly indicate.

When pull-up V_{st} , the pull-up resistor value is recommended **3.3K to 8.1 K Ω** .

【Note3】 Lamp lifetime is **defined** that it applied either ① or ② under this condition
 (Continuous turning on at $T_a=25^\circ C, V_{CON}=OV$)

① **Brightness becomes 50%** of the original value under standard condition.

② Lamps can't normally turn on at $T_a=0^\circ C$.

【Note4】 These **values are specified** as the ripple voltage of user's power supply which input the power to the backlight **inverter**. These do not include the returned ripple voltage from backlight inverter. 

7. Timing Characteristics of input signals

Timing diagrams of input signal are shown in Fig.2 - ①~③.

7-1. Timing characteristics

Parameter		Symbol	Mode	Min.	Typ.	Max.	Unit
Clock	Frequency	$1/T_c$	all	-	25,18	28.33	MHz
	High time	T_{ch}	all	10	-	-	ns
	Low time	T_{cl}	all	10	-	-	ns
Data	Setup time	T_{ds}	all	5	-	-	ns
	Hold time	T_{dh}	all	10	-	-	ns
Horizontal sync. signal	Cycle	TH	all	30.00	31.78	-	μs
			all	770	800	900	clock
	Pulse width	TH_p	all	2	96	200	clock
Vertical sync. signal	Cycle	TV	480-line	515	525	560	line
			400-line	445	449	560	line
			350-line	447	449	560	line
	Pulse width	TV_p	all	1	-	34	line
Horizontal display period		TH_d	all	640	640	640	clock
Hsync-Clock phase difference		TH_c	all	10	-	T_c-10	ns
Hsync-Vsync phase difference		TV_h	all	0	-	$TH-TH_p$	clock

Note) In case of **lower** frequency, the deterioration of display quality, flicker etc., maybe occurred. 

7-2. Horizontal display position

The horizontal display position is determined by ENAB signal and the input data corresponding to the rising edge of ENAB signal is displayed at the left end of the active area.

Parameter		symbol	Min.	Typ.	Max.	Unit	Remark
ENAB signal	Setup time	Tes	5	-	Tc- 10	ns	
	Pulse width	Tep	10	640	640	clock	
Hsync-ENAB phase difference		THE	44	-	164	clock	

Note) When ENAB is fixed "Low", the display starts from the data of C104(clock) as shown in Fig.2-①~③. When ENAB is fixed "High"*, the display starts from the data of C48(clock).

7-3. Vertical display position

The vertical display position is automatically centered in the active area at each mode of VGA ,480 -,400 -,and 350-line mode . Each mode is selected depending on the polarity of the synchronous signals described in 4-1 (Note1).

In each mode ,the data of TVn is displayed at the top line of the active area. And the display position will be centered on the screen like the following figure when the period of vertical synchronous signal, TV,is typical value.

In 400-, and 350-line mode, the data in the vertical data invalid period is also displayed, So ,inputting all data "O" is recommended during vertical data invalid period.
ENAB signal has no relation to the vertical display position.

mode	v-data start(TVs)	V-data period(TVd)	V-display start(TVn)	V-display period	unit	Remark
480	34	480	34	480	line	
400	34	400	443-TV	480	line	
350	61	350	445-TV	480	line	

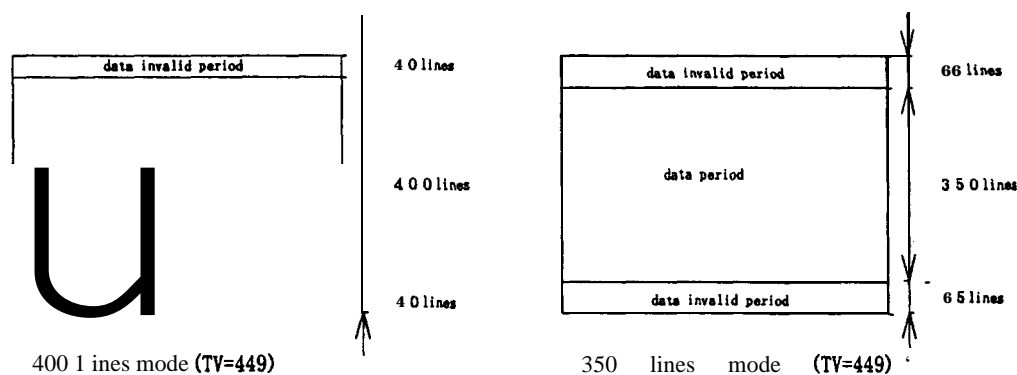

7-4. Input Data Signals and Display Position on the screen

Graphics and texts can be displayed on a $640 \times 3 \times 480$ dots panel with 16M colors by supplying **24** bit data signal (**8bit/color:256** gray scale).

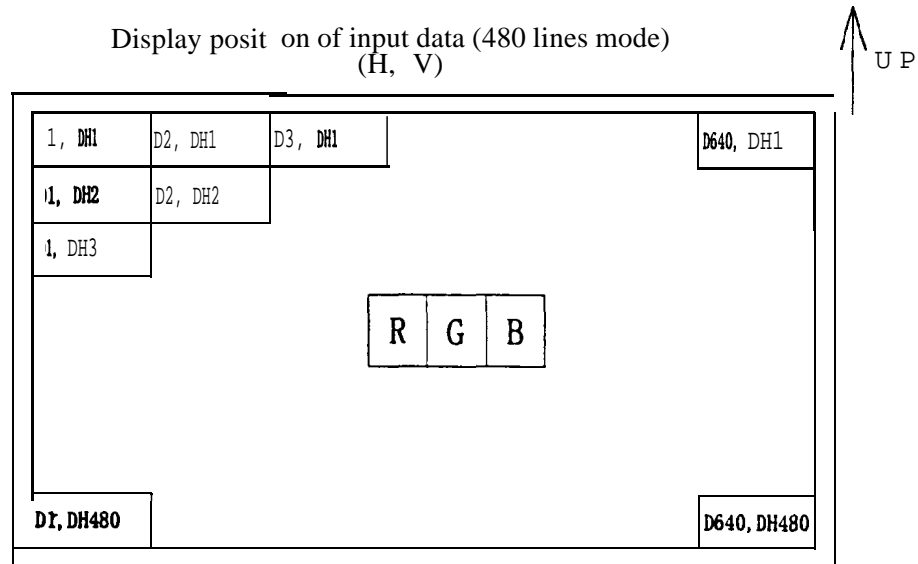

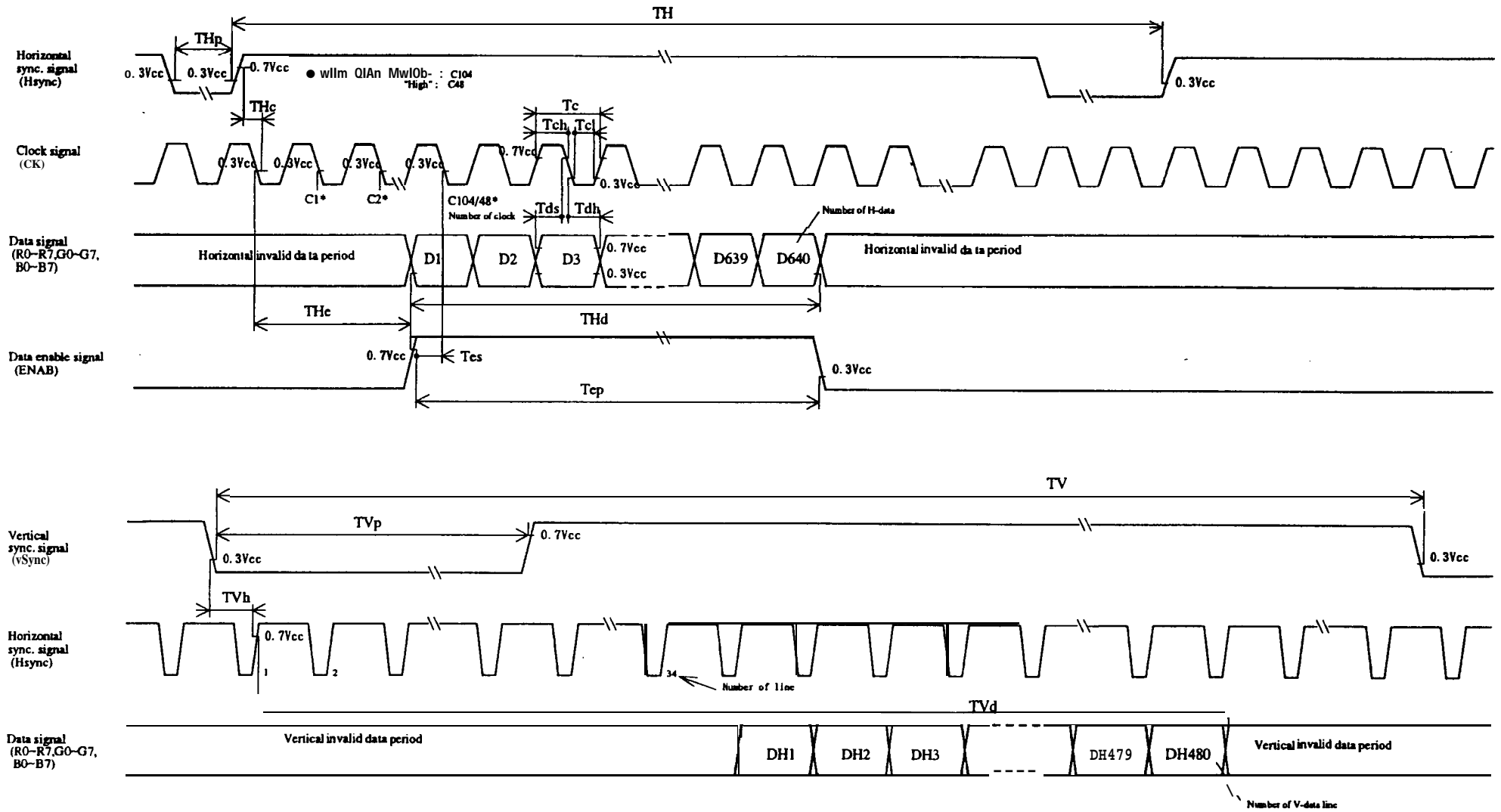

Fig 2-1 Input signal waveforms (480 line mode)

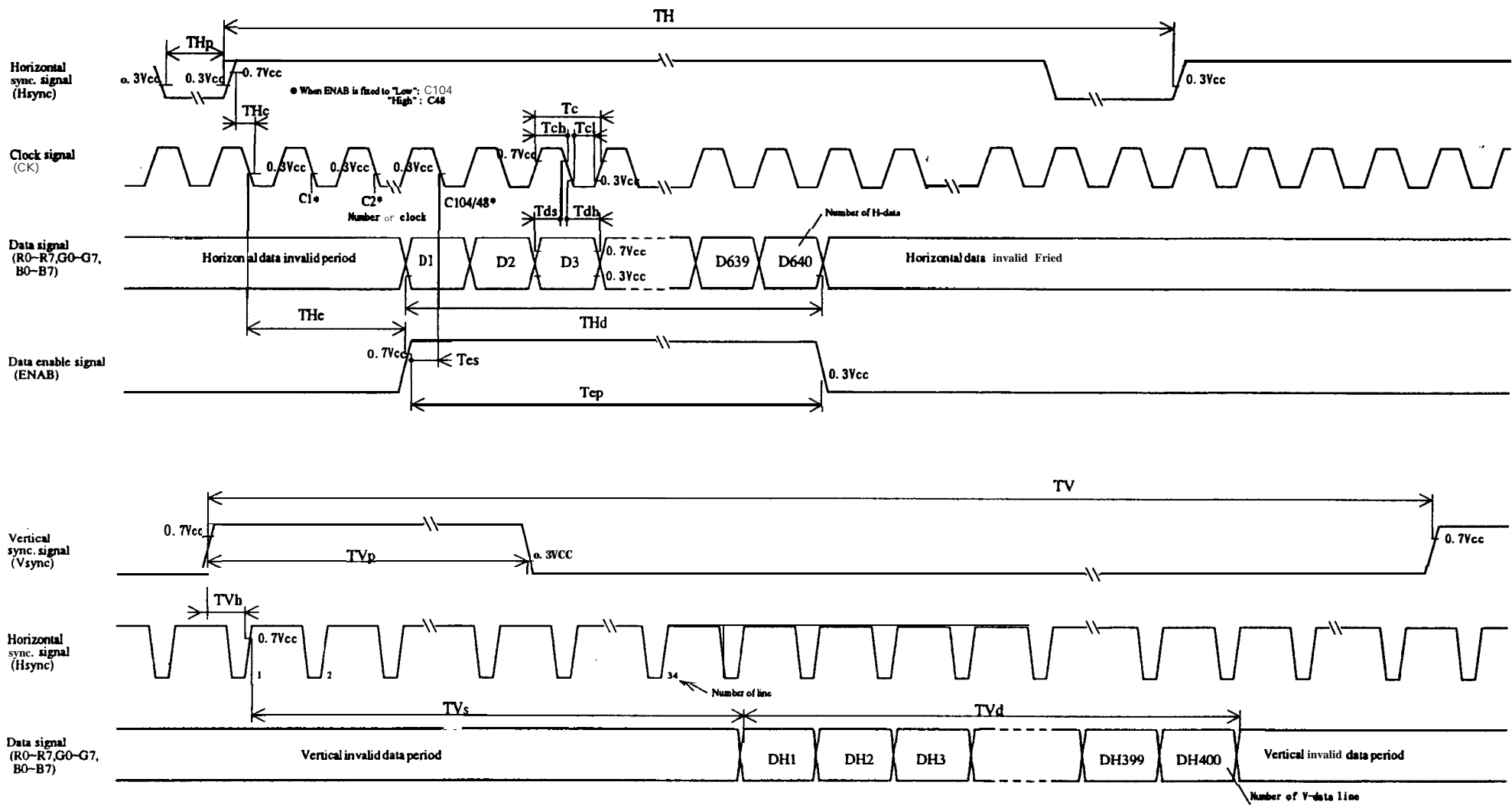

Fig.2-2 Input signal waveforms (400 line mode)

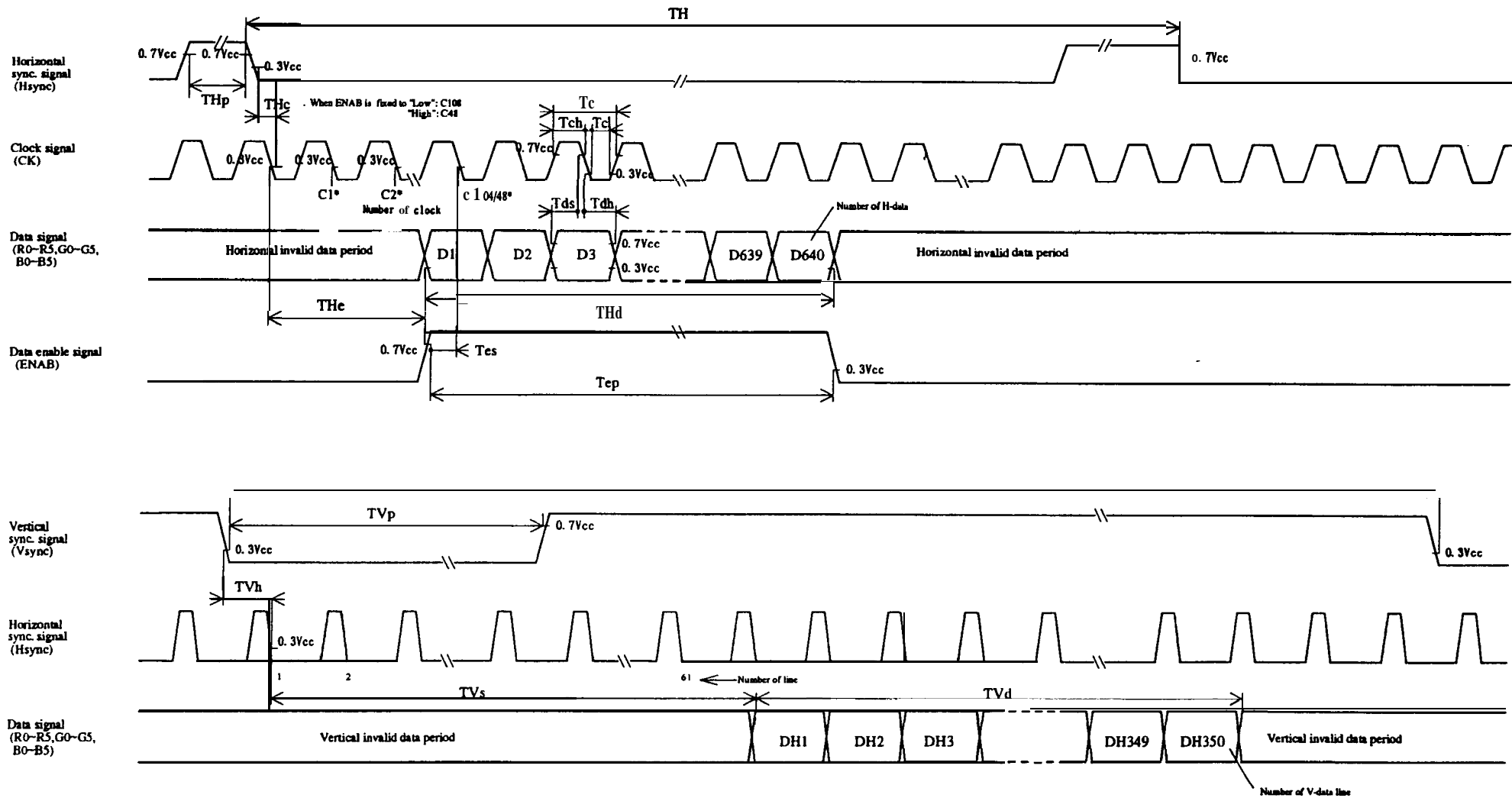

Fig.2-3 Input signal waveforms (350 line mode)

8. Input Signals, Basic Display Colors and Gray Scale of Each Color

Colors & Gray scale	Data signal																								
	GrayScale	R7	R6	R5	R4	R3	R2	R1	RO	G7	G6	G5	G4	G3	G2	G1	GO	B7	B6	B5	B4	B3	B2	B1	B0
Basic Color	Black		0	0	0	0	0	0	0	0	0	0	0	0	0	0	0	0	0	0	0	0	0	0	0
	Blue		0	0	0	0	0	0	0	0	0	0	000	0	0			1	1	1	11	111			
	Green	—	0	00	0	00	0	0		11	111	1	1	1				0	0	000	0	0	0		
	Cyan	—	0	00	0	0	0	00		1	1	1111	1	1				1	1	11	1	11	1		
	Red	—	1	11	1	11	1	1		0	0	0	0000	0				0	0	0	00	00	0		
	Magenta	—	1	11	1	11	1	1		0	0	0000	0	0				11	1	11	11	11	1		
	Yellow	—	1	11	1	111	1			1	1	1	1	0000				0	0	0	0	0	0	0	
	White		1	1	1	1	1	1	1	1	1	1	1	1	1	1	1	1	1	1	11	111			
Gray Scale of Red	Black	GS0	0	00	0	00	0	0	0	0	0	00	00	0			0	0	0	0	0	0	0		
	↑	GS1	0	0	0	0	0	0	1	0	0	0	000	0	0		0	0	0	00	00	0			
	Darker	GS2	000	0	00	1	0		0	0	0	0	0	0	0	0	0	0	00	00	0				
	↑	↓				↓						↓						↓							
	0	↓				↓						↓						↓							
	Brighter	GS253	1	11	1	1	101		0	0	0	0	0	0	0	0	0	0	0	0	0	0			
	↓	GS254	1	11	1	11	10		0	0	0	0	0	0	0	0	0	0	00	000					
	Red	GS255	1	11	1	11	1	1	0	0	00	0	00	0		0	0	0	0	0	0	0			
Gray Scale of Green	Black	GS0	0	00	0	00	0	0	0	0	0	0	0	0	0	0	0	0	00	000					
	↑	GS1	0	00	0	00	0	0	0	0	0	0	0	0	1	0	0	0	00	000					
	Darker	GS2	0	00	0	00	0	0	0	0	0000	1	0		0	0	0	00	000						
	↑	↓				↓						↓						↓							
	↓	↓				↓						↓						↓							
	Brighter	GS253	0	00	0	00	0	0	1	1	1	1	1	101	0	0	0	0	00	0					
	↓	GS254	0	00	0	00	00		1	1	1	1	1	1	0	0	0	0	00	000					
	Green	GS255	0	00	0	000	0		1	1	1	11	1	1	1	0	0	0	0	0	0	0			
Gray Scale of Blue	Black	GS0	0	0	0	0	0	0	0	0	0	0	0	000	0		0	0	0	00	0	00			
	↑	GS1	0	00	0	00	00		0	0	0	0	0	0	0	0	0	0	00	00	1				
	Darker	GS2	0	0	0	0	0	0	0	0	0	0	0	0	0	0	0	0	0	0	0	1	0		
	↑	↓				↓						↓						↓							
	0	↓				↓						↓						↓							
	Brighter	GS253	0	0	0	0	0	0	0	0	0	00	000	0		1	1	1	11	101					
	↓	GS254	0	000	00	0	0		0	0	0	0	0	0	0	1	1	1	11	1	10				
	Blue	GS255	0	00	0	00	0	0	0	0	00	00	0	0		1	1	1	11	11	1				

0 :Low level voltage, 1: High level voltage

Each basic color can be displayed in 256 gray scales from 8 bit data signals. According to the combination of total 24 bit data signals, the 1677M-color display can be achieved on the screen.

9. Optical Characteristics

Ta=25°C, =+5V

Parameter		Symbol	Condition	Min.	Typ.	Max.	Unit	Remark
Viewing angle range	Horizontal	021,022	CR>10	45	-	-	Deg.	【Note1,4】
	Vertical	$\theta 11$		10	-	-	Deg.	
		$\theta 12$		30	-	-	Deg.	
Contrast ratio		C R	Opt imum Viewing Angle	100	-	-		【Note2,4】
Response time	Rise	τr	$\theta = 0^\circ$	-	30	-	m s	【Note3,4】
	Decay	τd		-	50	-	m s	
Chromaticity of white		x		-	0.313	-		【Note4 1】
		y		-	0.329	-		
Luminance of white		Y_L		-	180	-	cd/m ²	【Note4,6】
White Uniformity		δw		-	-	1.45		【Note5】

※The measurement shall be executed 30 minutes after lighting at rating.

The optical characteristics shall be measured in a dark room or equivalent state with the method shown in Fig.3 below.

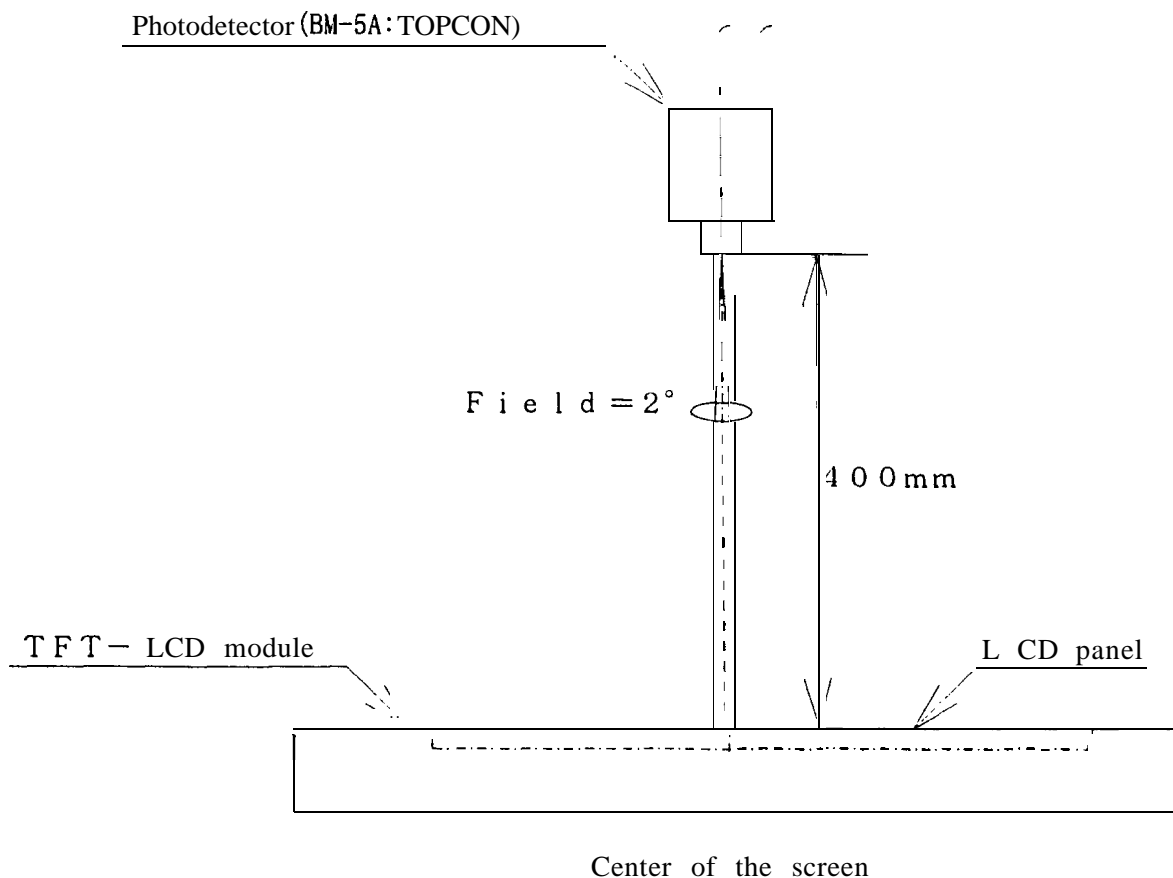
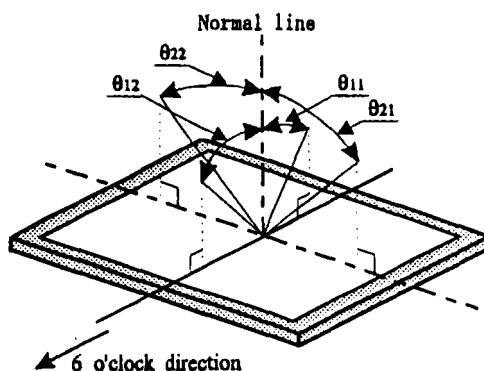

Fig.3 Optical characteristics measurement method

[Note1] Definitions of viewing angle range:



[Note2] Definition of contrast ratio

The contrast ratio is defined as the following.

$$\text{Contrast Ratio (CR)} = \frac{\text{Luminance (brightness) with all pixels white}}{\text{Luminance (brightness) with all pixels black}}$$

[Note3] Definition of response time:

The response time is defined as the following figure and shall be measured by switching the input signal for "black" and "white".

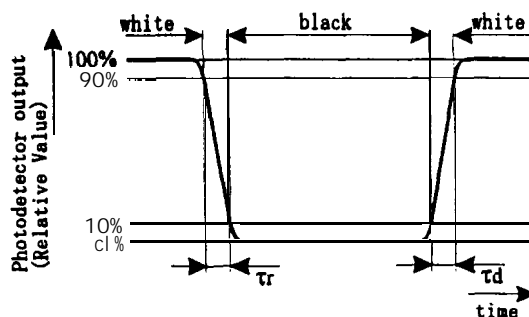

[Note4] This shall be measured at center of the screen.

[Note5] Definition of white uniformity:

White uniformity is defined as the following with five measurements (A-E).

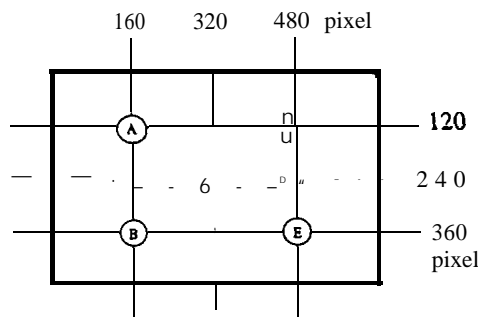

$$\delta w = \frac{\text{Maximum Luminance of five points (brightness)}}{\text{Minimum Luminance of five points (brightness)}}$$

[Note6] Maximum Luminance

10. Display Quantity

The **display** quality of the color **TFT-LCD** module shall be in compliance with the **Incoming** Inspection Standard.

11. Handling Precautions

- a) Be sure to turn off the power supply when inserting or **disconnecting** the cable.
- b) Be sure to design the cabinet so that the module can be installed without any extra stress such as warp or twist.
- c) Since the front polarizer is easily damaged, pay attention not to scratch it.
- d) Wipe off water **drop** immediately, Long contact with water may cause discoloration or spots.
- e) When the panel surface is soiled, wipe it with absorbent cotton or other soft cloth.
- f)** Since the panel is made of glass, it may break or crack if dropped or bumped on hard surface. Handle with care.
- g) Since CMOS LSI is used in this module, take care of static electricity and touch the ground through yourself when handling.
- h) **Observe** all other precautionary requirements in handling components.
- i) This module has its circuitry **PCBs** on the rear side and should be carefully handled in order not to be stressed.
- j) Laminated film is attached to the module surface to prevent **it** from being scratched . Peel the **film** off slowly, just before the use, with strict attention to electrostatic charges. Ionized air shall be blown over during the action. Blow off 'dust' on the polarizer by using an ionized nitrogen gun, etc.

12. Packing form

- a) Piling number of cartons : MAX.6
- b) Package quantity in one carton: **10pcs**
- c) Carton size : 370(W) X 470(H) X **590(D)mm**
- d) Total mass of 1 carton filled with full modules: **18,000g**

Packing form is shown in Fig.4

3. Reliability test items

No.	Test item	Conditions
1	High temperature storage test	Ta=60°C 240h
2	Low temperature storage test	Ta= -25°C 240h
3	High temperature & high humidity operation test	Ta= 40°C ; 95%RH 240h (No condensation)
4	High temperature operation test	Ta=50°C 240h
5	Low temperature operation test	Ta=0°C 240h
6	Vibration test (non- operating)	Frequency: 10~57Hz/Vibration width (one side) :0.075mm : 58~500Hz/Gravity:9.8m/s ² Sweep time: 11 minutes Test period :3 hours (1 hour for each direction of X,Y,Z)
7	Shock test (non- operating)	Max. gravity: 490m/s ² Pulse width: 11 ms, half sine wave Direction: ±X, ±Y, ±Z once for each direction.

[Result Evaluation Criteria]

Under the display quality test conditions with normal operation state, these shall be no change which may affect practical display function.

14. Others

1) Lot No. Label:

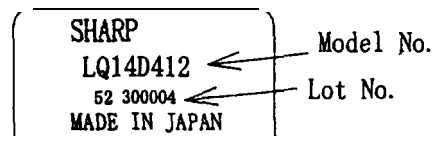

2) Adjusting volume have been set optimally before shipment, so do not change any adjusted value.

If adjusted value is changed, the specification may not be satisfied.

3) Disassembling the module can cause permanent damage and should be strictly avoided.

4) Please be careful since image retention may occur when a fixed pattern is displayed for a long time.

5) If any problem occurs in relation to the description of this specification , it shall be resolved through discussion with spirit of cooperation.

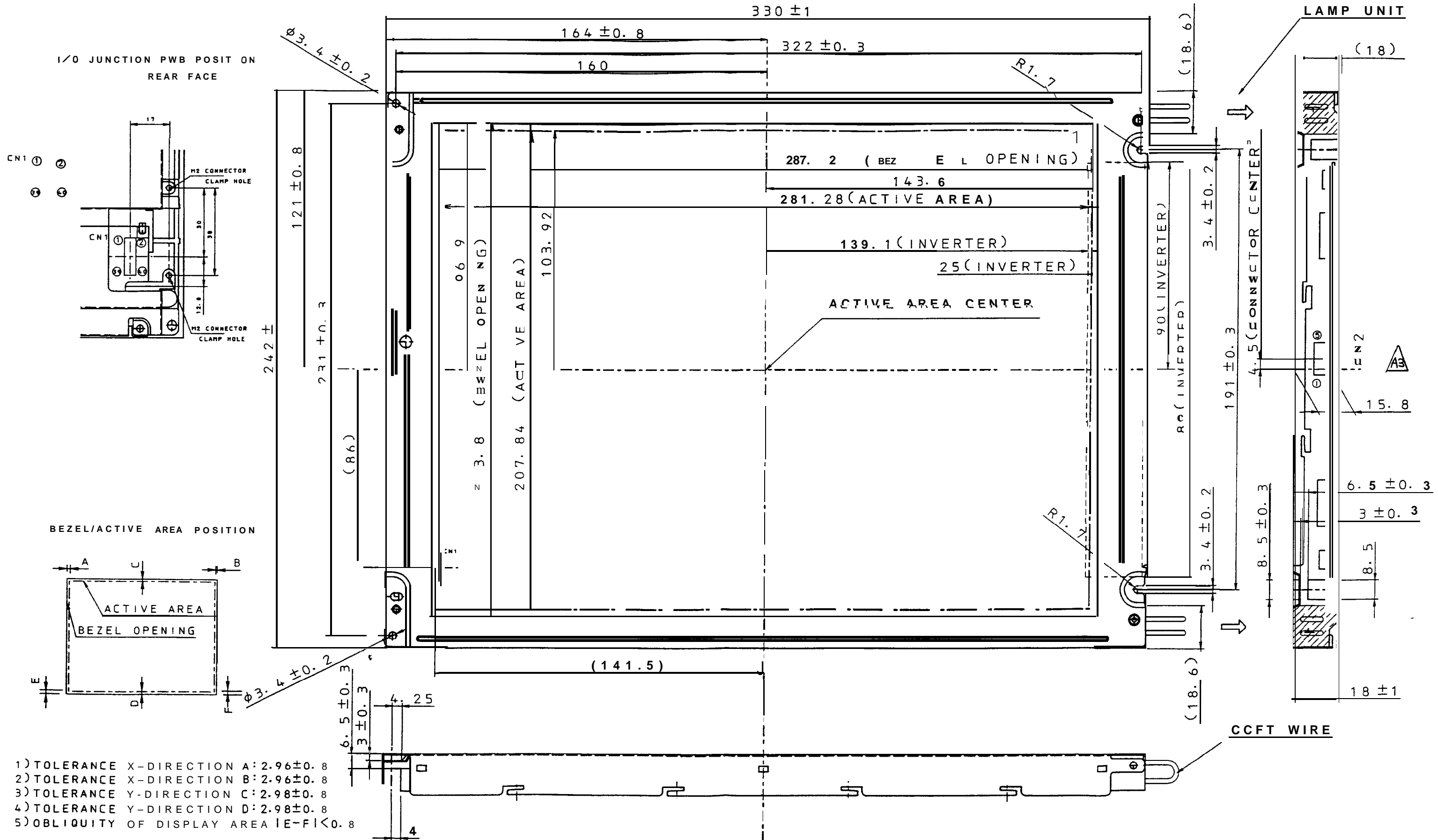

NOTES

UNSPECIFIED TOLERANCE TO BE ± 0.5

LQI 4D412 MODULE OUTLINE DIMENSIONS