

PREPARED BY : DATE

APPROVED BY : DATE

SHARP

LCD DEVELOPMENT GROUP
SHARP CORPORATION

SPEC No. LD-12604

FILE No.

ISSUE : Jun. 15, 2000

PAGE : 18 pages

APPLICABLE GROUP

LCD DEVELOPMENT GROUP

SPECIFICATION

DEVICE SPECIFICATION FOR

TFT-LCD Module

MODEL No.

LQ104V1DC31

CUSTOMER'S APPROVAL

DATE _____

BY _____

PRESENTED

BY Makoto Takeda

M. TAKEDA

Department General Manager

Development Engineering Dept. II

TFT Division. II

TFT LIQUID CRYSTAL DISPLAY GROUP

SHARP CORPORATION

1. Application

This specification applies to color TFT-LCD module, LQ104V1DC31.

These specification sheets are the proprietary product of SHARP CORPORATION ("SHARP") and include materials protected under copyright of SHARP. Do not reproduce or cause any third party to reproduce them in any form or by any means, electronic or mechanical, for any purpose in whole or in part, without the express written permission of SHARP.

The device listed in these specification sheets was designed and manufactured for use in general electronic equipment.

In case of using the device for applications such as control and safety equipment for transportation (aircraft, trains, automobiles, etc.), rescue and security equipment and various safety related equipment which require higher reliability and safety, take into consideration that appropriate measures such as fail-safe functions and redundant system design should be taken.

Do not use the device for equipment that requires an extreme level of reliability, such as aerospace applications, telecommunication equipment (trunk lines), nuclear power control equipment and medical or other equipment for life support.

SHARP assumes no responsibility for any damage resulting from the use of the device which does not comply with the instructions and the precautions specified in these specification sheets.

Contact and consult with a SHARP sales representative for any questions about this device.

2. Overview

This module is a color active matrix LCD module incorporating amorphous silicon TFT (Thin Film Transistor). It is composed of a color TFT-LCD panel, driver ICs, control circuit and power supply circuit. Graphics and texts can be displayed on a $640 \times 3 \times 480$ dots panel with 262,144 colors by supplying 18 bit data signal (6bit/color), four timing signals, +5V DC supply voltage for TFT-LCD panel driving.

The TFT-LCD panel used for this module is a low-reflection and higher-color-saturation type. Therefore, this module is also suitable for the multimedia use. Viewing angle is 6 o'clock direction. This module is the type of wide viewing angle.

3. Mechanical Specifications

Parameter	Specifications	Unit
Display size	26 (10.4") Diagonal	cm
Active area	211.2(H)×158.4(V)	mm
Pixel format	640(H)×480(V)	pixel
	(1 pixel=R+G+B dots)	—
Pixel pitch	0.330(H)×0.330(V)	mm
Pixel configuration	R,G,B vertical stripe	—
Display mode	Normally white	—
Unit outline dimensions *1	265.0(W)×195.0(H)×10.7(D)	mm
Mass	370±20	g
Surface treatment	Anti-glare Hard-coating 3H (Haze value = 28 %)	—

*1.Outline dimensions is shown in Fig.1

4. Input Terminals

4-1. TFT-LCD panel driving

CN1 Used connector:DF9BA-31P-1V (Hirose Electric Co., Ltd.)

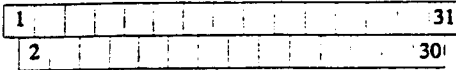

CN1 pin arrangement from module surface
(Transparent view)

Corresponding connector: DF9 -31S-1V (")

DF9A-31S-1V (")

DF9B-31S-1V (")

DF9M-31S-1V (")

Pin No.	Symbol	Function	Remark
1	GND	—	—
2	CK	Clock signal for sampling each data signal	—
3	Hsync	Horizontal synchronous signal	[Note1]
4	Vsync	Vertical synchronous signal	[Note1]
5	GND	—	—
6	R0	RED data signal(LSB)	—
7	R1	RED data signal	—
8	R2	RED data signal	—
9	R3	RED data signal	—
10	R4	RED data signal	—
11	R5	RED data signal(MSB)	—
12	GND	—	—
13	G0	GREEN data signal(LSB)	—
14	G1	GREEN data signal	—
15	G2	GREEN data signal	—
16	G3	GREEN data signal	—
17	G4	GREEN data signal	—
18	G5	GREEN data signal(MSB)	—
19	GND	—	—
20	B0	BLUE data signal(LSB)	—
21	B1	BLUE data signal	—
22	B2	BLUE data signal	—
23	B3	BLUE data signal	—
24	B4	BLUE data signal	—
25	B5	BLUE data signal(MSB)	—
26	GND	—	—
27	ENAB	Signal to settle the horizontal display position	[Note2]
28	Vcc	+5.0V power supply	—
29	Vcc	+5.0V power supply	—
30	R/L	Horizontal display mode select signal	[Note3]
31	U/D	Vertical display mode select signal	[Note4]

[Note1] 480 line, 400 line or 350 line mode is selected by the polarity combination of the both synchronous signals.

Mode	480 lines	400 lines	350 lines
Hsync	negative	negative	positive
Vsync	negative	positive	negative

[Note2] The horizontal display start timing is settled in accordance with a rising timing of ENAB signal. In case ENAB is fixed "Low", the horizontal start timing is determined as described in 7-2. Don't keep ENAB "High" during operation.

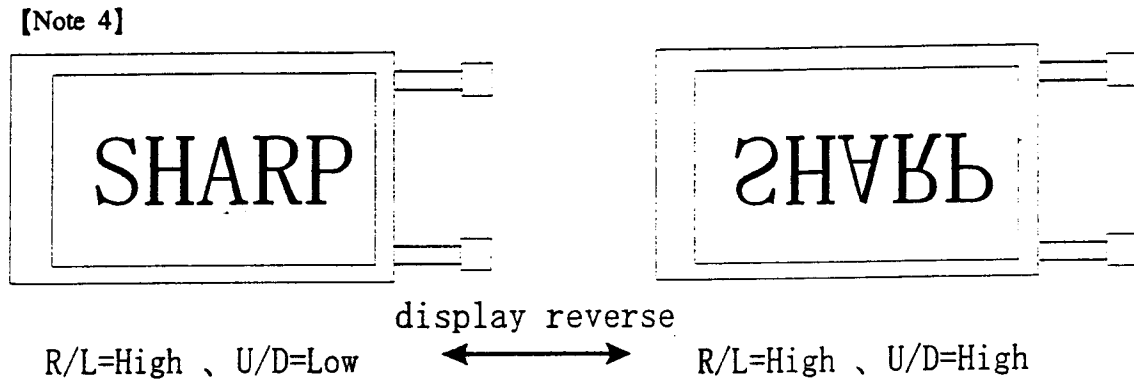
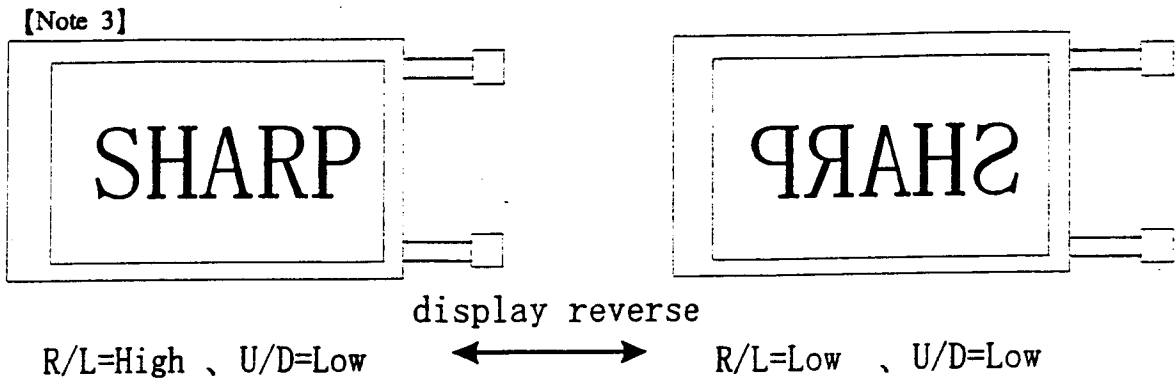

5. Absolute Maximum Ratings

Parameter	Symbol	Condition	Ratings	Unit	Remark
Input voltage	V_I	$T_a=25^{\circ}\text{C}$	$-0.3 \sim V_{cc}+0.3$	V	[Note1]
+5V supply voltage	V_{cc}	$T_a=25^{\circ}\text{C}$	$0 \sim +6$	V	—
Storage temperature	T_{stg}	—	$-25 \sim +70$	$^{\circ}\text{C}$	[Note2]
Operating temperature ①	T_{opp}	—	$0 \sim +70$	$^{\circ}\text{C}$	[Note3]
Operating temperature ②	T_{op}	—	$0 \sim +55$	$^{\circ}\text{C}$	[Note4]
Light source wave length	λ_I	—	≥ 400	nm	[Note5]
Light source luminance	—	—	≤ 14000	cd/m^2	[Note5]

[Note1] CK,R0~R5,G0~G5,B0~B5,Hsync,Vsync,ENAB,R/L,U/D

[Note2] Humidity : 95%RH Max. at $T_a \leq 40^{\circ}\text{C}$.

Maximum wet-bulb temperature at 39°C or less at $T_a > 40^{\circ}\text{C}$.

No condensation.

[Note3] Panel surface temperature

[Note4] Module ambient temperature

[Note5] Measurement point : panel surface (Backlight mounting side)

The light source used fluorescence lamp with tree wave length.

6. Electrical Characteristics

6-1. TFT-LCD panel driving

Ta=25°C

Parameter	Symbol	Min.	Typ.	Max.	Unit	Remark
+5V Supply voltage	V _{CC}	+4.5	+5.0	+5.5	V	[Note1]
	I _{CC}	—	280	450	mA	[Note2]
Permissive input ripple voltage	V _{RF}	—	—	100	mVp-p	V _{CC} =+5V
Input voltage (Low)	V _{IL}	—	—	0.3V _{CC}	V	[Note3]
Input voltage (High)	V _{IH}	0.7V _{CC}	—	—	V	
Input current (low)	I _{OL1}	—	—	1.0	μA	V _I =0V [Note4]
	I _{OL2}	—	—	60.0	μA	V _I =0V [Note5]
Input current (High)	I _{OH1}	—	—	1.0	μA	V _I =V _{CC} [Note6]
	I _{OH2}	—	—	60.0	μA	V _I =V _{CC} [Note7]

【 Note1 】

V_{CC}-turn-on conditions

- t 1 ≤ 15 m s
- 0 < t 2 ≤ 10 m s
- 0 < t 3 ≤ 10 m s
- 0 < t 4 ≤ 1 s
- t 5 > 1 s

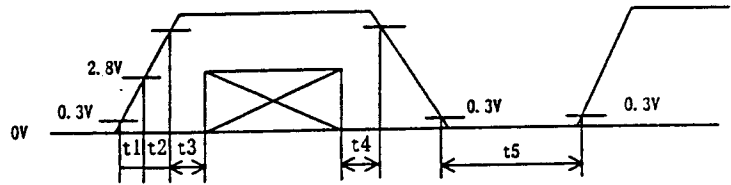

V_{CC}-dip conditions

- 1) 2.7V ≤ V_{CC} < 4.5V
t_d ≤ 10ms
- 2) V_{CC} < 2.7V

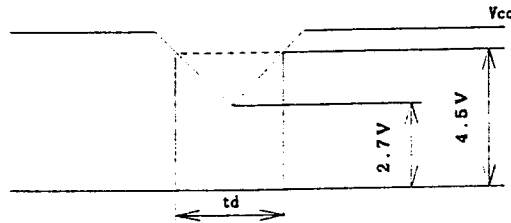

V_{CC}-dip conditions should also follow the V_{CC}-turn-on conditions

【Note2】 Typical current situation : 16-gray-bar pattern.

480 line mode

V_{CC}=+5.0V

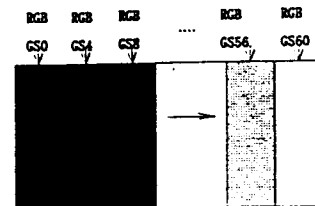

【Note3】 CK,R0~R5,G0~G5,B0~B5,Hsync,Vsync,ENAB,R/L,U/D

【Note4】 CK,R0~R5,G0~G5,B0~B5,Hsync,Vsync,ENAB

【Note5】 R/L

【Note6】 CK,R0~R5,G0~G5,B0~B5,Hsync,Vsync

【Note7】 ENAB,U/D

7. Timing Characteristics of input signals

Timing diagrams of input signal are shown in Fig.2-1~3.

7-1. Timing characteristics

Parameter		Symbol	Mode	Min.	Typ.	Max.	Unit	Remark
Clock	Frequency	1/Tc	all	—	25.18	28.33	MHz	—
	High time	Tch	"	5	—	—	ns	—
	Low time	Tcl	"	10	—	—	ns	—
Data	Setup time	Tds	"	5	—	—	ns	—
	Hold time	Tdh	"	10	—	—	ns	—
Horizontal sync. signal	Cycle	TH	"	30.00	31.78	—	μs	—
			"	750	800	900	clock	—
	Pulse width	THp	"	2	96	200	clock	—
Vertical sync. signal	Cycle	TV	480	515	525	560	line	—
			400	446	449	480	line	—
			350	447	449	510	line	—
	Pulse width	TVp	all	1	—	34	line	—
Horizontal display period		THd	"	640	640	640	clock	—
Hsync-Clock phase difference		THc	"	10	—	Tc-10	ns	—
Hsync-Vsync phase difference		TVh	"	0	—	TH-THp	clock	—

Note) In case of lower frequency, the deterioration of display quality, flicker etc., may be occurred.

7-2. Horizontal display position

The horizontal display position is determined by ENAB signal and the input data corresponding to the rising edge of ENAB signal is displayed at the left end of the active area.

Parameter		symbol	Min.	Typ.	Max.	Unit	Remark
Enable signal	Setup time	Tes	5	—	Tc-10	ns	—
	Pulse width	Tep	2	640	640	clock	—
Hsync-Enable signal phase difference		THE	44	—	TH-664	clock	—

Note) When ENAB is fixed "Low", the display starts from the data of C104(clock) as shown in Fig.2-1~3. Be careful that the module does not work when ENAB is fixed "High".

When the phase difference is below 104 clock, keep the "High" level of ENAB signal longer than 104-The. If will not be kept, the display starts from the data of C104(clock).

7-3. Vertical display position

The vertical display position is automatically centered in the active area at each mode of VGA, 480-, 400-, and 350-line mode. Each mode is selected depending on the polarity of the synchronous signals described in 4-1(Note1).

In each mode, the data of TV_n is displayed at the top line of the active area. And the display position will be centered on the screen like the following figure when the period of vertical synchronous signal, TV, is typical value.

In 400-, and 350-line mode, the data in the vertical data invalid period is also displayed. So, inputting all data "0" is recommended during vertical data invalid period.

ENAB signal has no relation to the vertical display position.

mode	V-data start(TVs)	V-data period(TVd)	V-display start(TVs)	V-display period	Unit	Remark
480	34	480	34	480	line	--
400	34	400	443-TV	480	line	--
350	61	350	445-TV	480	line	--

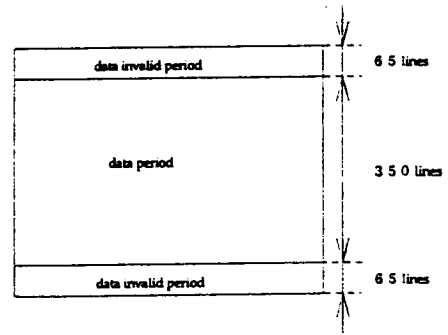
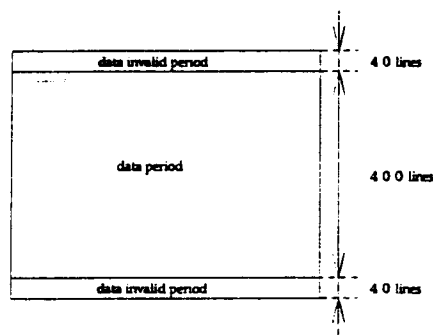

7-4. Input Data Signals and Display Position on the screen

Display position of input data (480 lines mode)

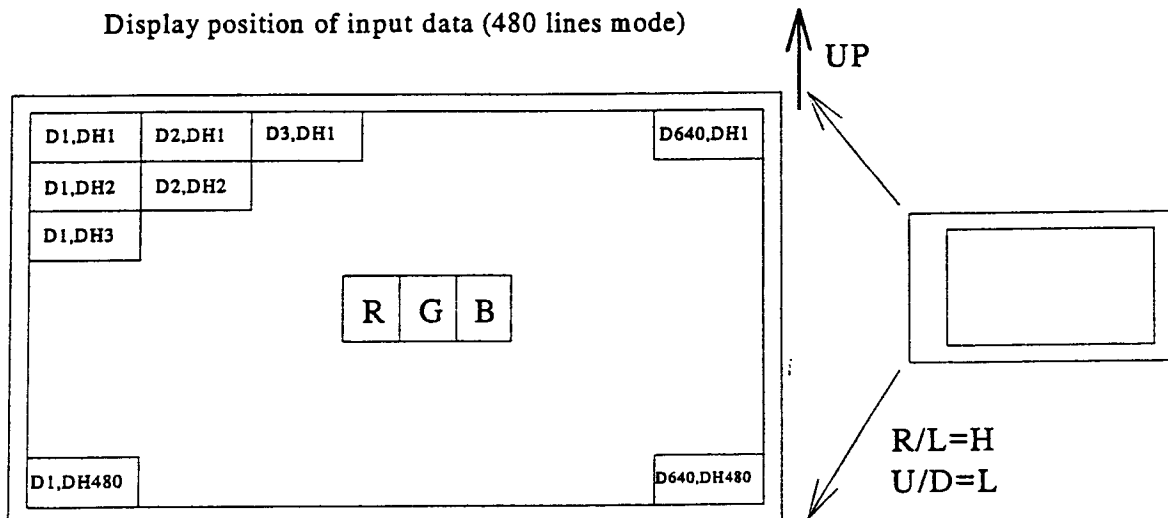

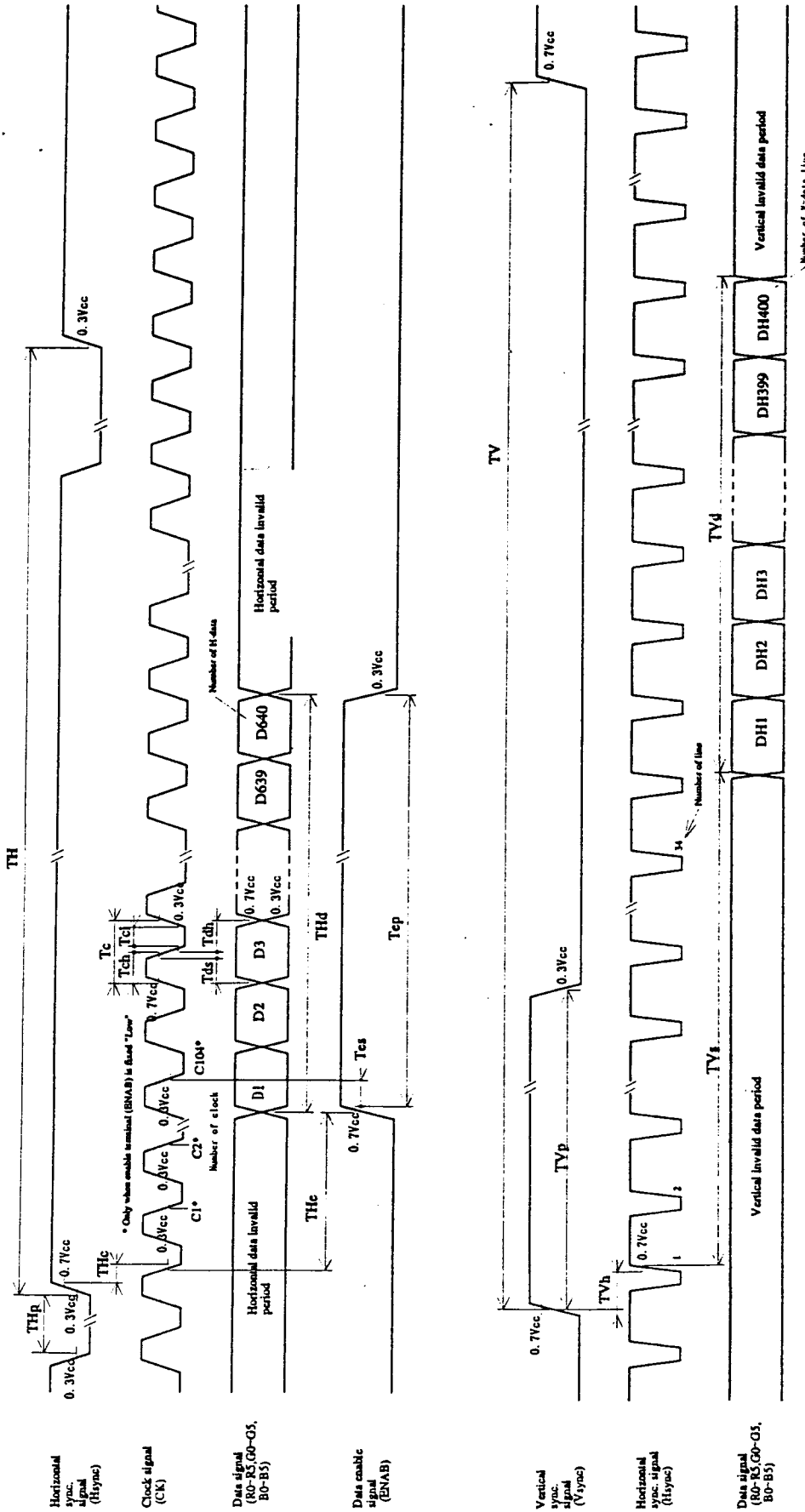
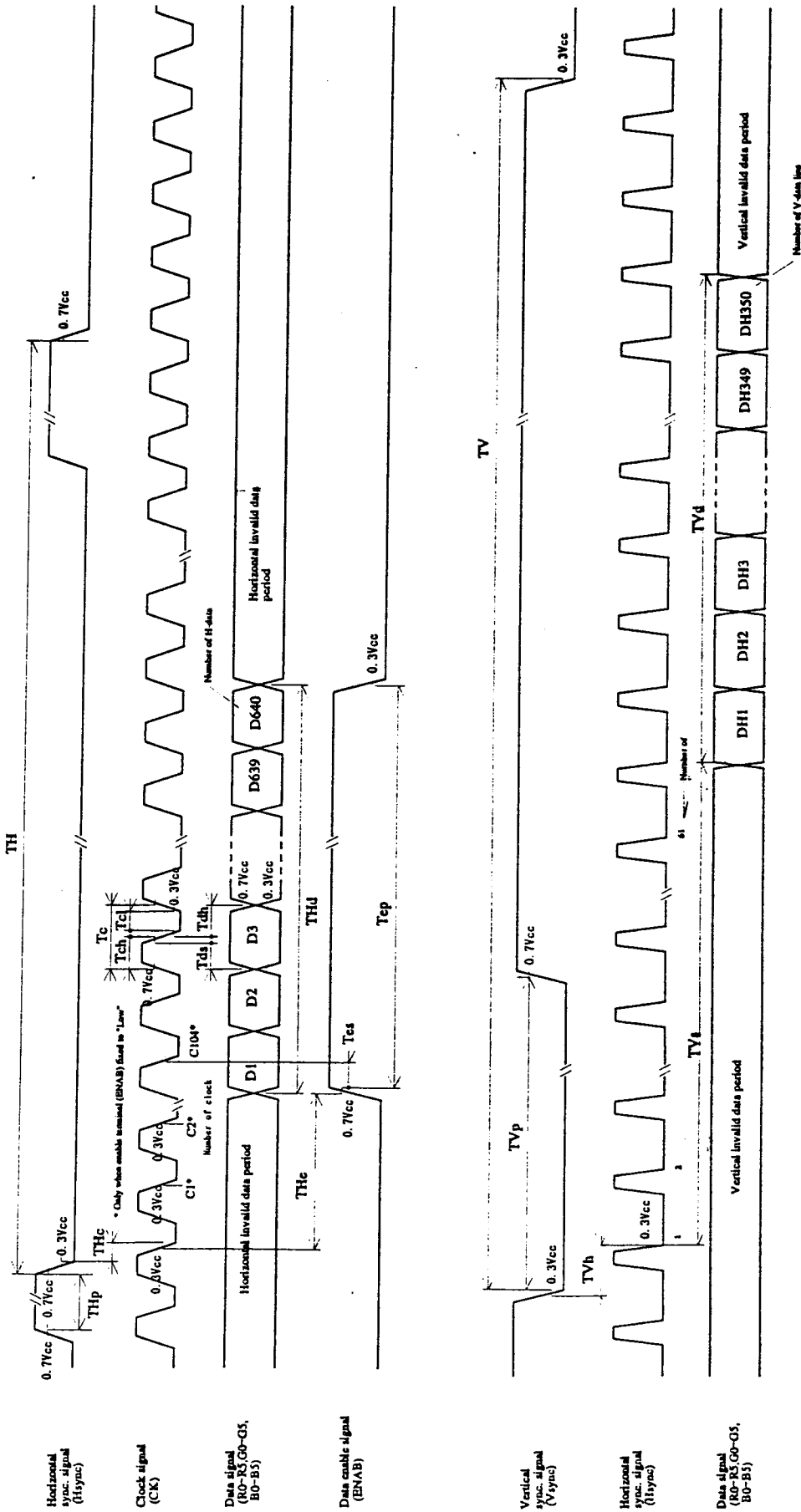

Fig.2-2 Input signal waveforms (400 line mode)



8. Input Signals, Basic Display Colors and Gray Scale of Each Color

Colors & Gray scale		Data signal																		
		GrayScale	R0	R1	R2	R3	R4	R5	G0	G1	G2	G3	G4	G5	B0	B1	B2	B3	B4	B5
Basic color	Black	—	0	0	0	0	0	0	0	0	0	0	0	0	0	0	0	0	0	0
	Blue	—	0	0	0	0	0	0	0	0	0	0	0	0	1	1	1	1	1	1
	Green	—	0	0	0	0	0	0	1	1	1	1	1	1	0	0	0	0	0	0
	Cyan	—	0	0	0	0	0	0	1	1	1	1	1	1	1	1	1	1	1	1
	Red	—	1	1	1	1	1	1	0	0	0	0	0	0	0	0	0	0	0	0
	Magenta	—	1	1	1	1	1	1	0	0	0	0	0	0	1	1	1	1	1	1
	Yellow	—	1	1	1	1	1	1	1	1	1	1	1	1	0	0	0	0	0	0
	White	—	1	1	1	1	1	1	1	1	1	1	1	1	1	1	1	1	1	1
Gray Scale of red	Black	GS0	0	0	0	0	0	0	0	0	0	0	0	0	0	0	0	0	0	0
	↑	GS1	1	0	0	0	0	0	0	0	0	0	0	0	0	0	0	0	0	0
	Darker	GS2	0	1	0	0	0	0	0	0	0	0	0	0	0	0	0	0	0	0
	↑	↓				↓					↓					↓				
	↓	↓				↓					↓					↓				
	Brighter	GS61	1	0	1	1	1	1	0	0	0	0	0	0	0	0	0	0	0	0
	↓	GS62	0	1	1	1	1	1	0	0	0	0	0	0	0	0	0	0	0	0
	Red	GS63	1	1	1	1	1	1	0	0	0	0	0	0	0	0	0	0	0	0
Gray Scale of green	Black	GS0	0	0	0	0	0	0	0	0	0	0	0	0	0	0	0	0	0	0
	↑	GS1	0	0	0	0	0	0	1	0	0	0	0	0	0	0	0	0	0	0
	Darker	GS2	0	0	0	0	0	0	0	1	0	0	0	0	0	0	0	0	0	0
	↑	↓				↓					↓					↓				
	↓	↓				↓					↓					↓				
	Brighter	GS61	0	0	0	0	0	0	1	0	1	1	1	1	0	0	0	0	0	0
	↓	GS62	0	0	0	0	0	0	0	1	1	1	1	1	0	0	0	0	0	0
	Green	GS63	0	0	0	0	0	0	1	1	1	1	1	1	0	0	0	0	0	0
Gray Scale of blue	Black	GS0	0	0	0	0	0	0	0	0	0	0	0	0	0	0	0	0	0	0
	↑	GS1	0	0	0	0	0	0	0	0	0	0	0	0	1	0	0	0	0	0
	Darker	GS2	0	0	0	0	0	0	0	0	0	0	0	0	0	1	0	0	0	0
	↑	↓				↓					↓					↓				
	↓	↓				↓					↓					↓				
	Brighter	GS61	0	0	0	0	0	0	0	0	0	0	0	0	1	0	1	1	1	1
	↓	GS62	0	0	0	0	0	0	0	0	0	0	0	0	0	1	1	1	1	1
	Blue	GS63	0	0	0	0	0	0	0	0	0	0	0	0	1	1	1	1	1	1

0 :Low level voltage, 1 : High level voltage

Each basic color can be displayed in 64 gray scales from 6 bit data signals. According to the combination of total 18 bit data signals, the 262,144-color display can be achieved on the screen.

9. Optical Characteristics

Ta=25°C, Vcc=+5V

Parameter		Symbol	Condition	Min.	Typ.	Max.	Unit	Remark
Viewing angle Range	Horizontal	$\theta 21$	$CR \geq 5$	60	70	—	Deg.	[Note1,4]
		$\theta 22$		60	70	—	Deg.	
	Vertical	$\theta 11$		35	40	—	Deg.	
		$\theta 12$		55	70	—	Deg.	
Contrast ratio		CR	$\theta = 0^\circ$ Best viewing angle	150 —	— 300	— —	— —	[Note2,4]
Response time	Rise	τr	$\theta = 0^\circ$	—	20	—	ms	[Note3,4]
	Decay	τd		—	40	—	ms	
Chromaticity of white		X		—	0.305	—	—	[Note4]
		Y		—	0.329	—	—	
Transmissivity		τr		6.10	7.10	7.70	%	
Direction of panel viewing angle		—	—	6			o'clock	[Note5]

[Use the backlight of LQ10D421 for measurement]

※The measurement shall be executed 30 minutes after lighting at rating.

The optical characteristics shall be measured in a dark room or equivalent state with the method shown in Fig.3 below.

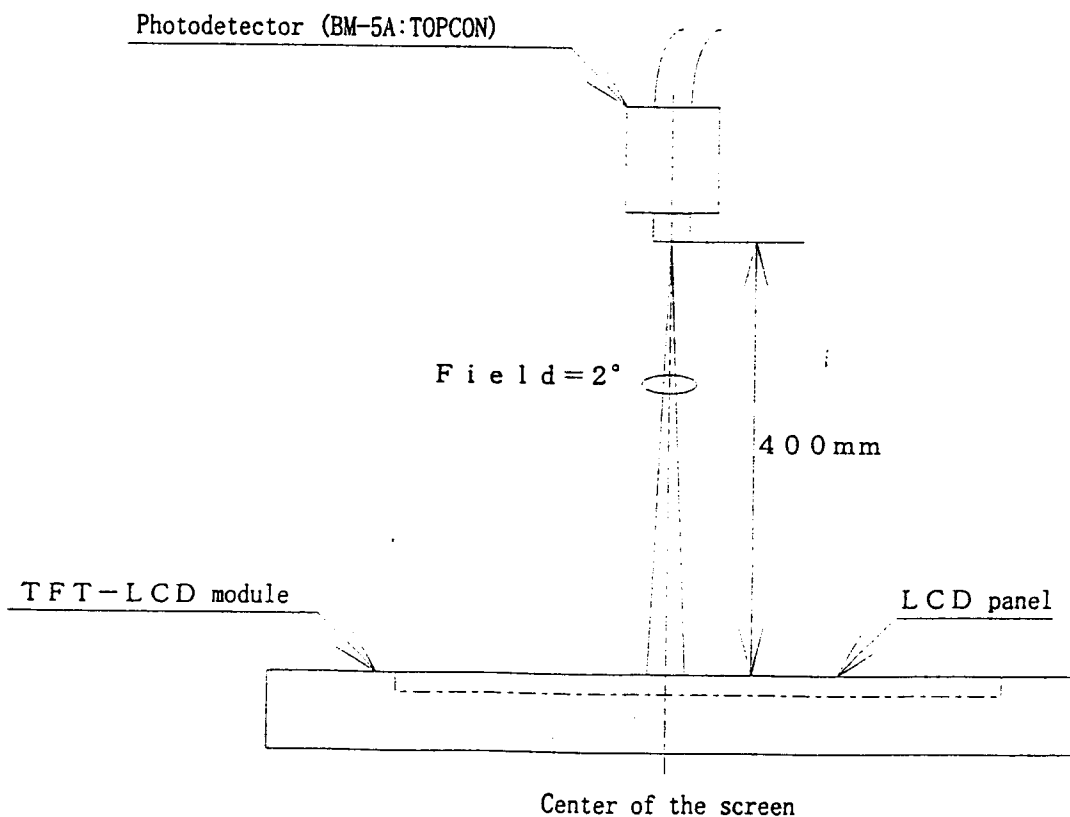
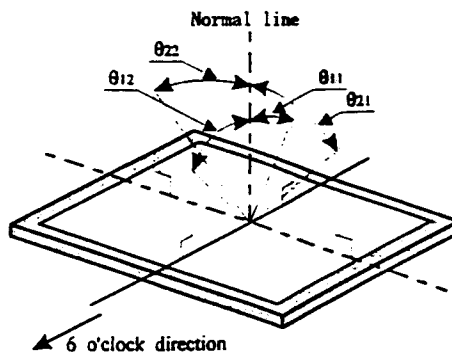

Fig.3 Optical characteristics measurement method

[Note1] Definitions of viewing angle range:



[Note2] Definition of contrast ratio:

The contrast ratio is defined as the following.

$$\text{Contrast Ratio (CR)} = \frac{\text{Luminance (brightness) with all pixels white}}{\text{Luminance (brightness) with all pixels black}}$$

[Note3] Definition of response time:

The response time is defined as the following figure and shall be measured by switching the input signal for "black" and "white".

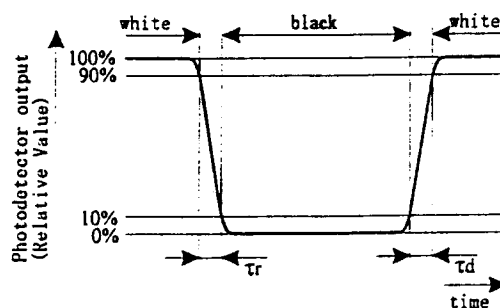

[Note4] This shall be measured at center of the screen.

[Note5] In the direction of 6 o'clock, Gray scale reverse occurs.

10. Display Quality

The display quality of the color TFT-LCD module shall be in compliance with the Incoming Inspection Standard.

11. Handling Precautions

- a) Be sure to turn off the power supply when inserting or disconnecting the cable.
- b) Be sure to design the cabinet so that the module can be installed without any extra stress such as warp or twist.
- c) Since the front polarizer is easily damaged, pay attention to avoid rubbing with something hard or sharp.
- d) Wipe off water drop immediately. Long contact with water may cause discoloration or spots.
- e) When the panel surface is soiled, wipe it with absorbent cotton or other soft cloth.
- f) Since the panel is made of glass and refined wires and components, it may break, crack or internal wire breaking if dropped or bumped on hard surface.
Handle with care.
- g) Since CMOS LSI is used in this module, take care of static electricity and injure the human earth when handling.
- h) Observe all other precautionary requirements in handling components.
- i) This module has its circuitry PCBs on the rear side and should be carefully handled in order not to be stressed.
- j) Laminated film is attached to the module front and back surface to prevent it from being scratched. Peel the film off slowly, just before the use, with strict attention to electrostatic charges. Ionized air shall be blown over during the action. Blow off 'dust' on the polarizer by using an ionized nitrogen gun, etc. (refer to page 18)
- k) When you use the module, please apply enough EMI countermeasure by using optimum backlight system etc..
- l) Please do not expose the LCD panel to direct sunlight. Lightproof shade etc. should be attached when LCD panel is used under such environment.

12. Packing form

- a) Piling number of cartons : MAX. 7
- b) Package quantity in one carton : 20pcs
- c) Carton size : 525(W) × 309(D) × 377(H)mm
- d) Total mass of 1 carton filled with full modules : 12.5kg

13. Reliability test items

No.	Test item	Conditions
1	High temperature storage test	Ta=70°C 240h
2	Low temperature storage test	Ta=-25°C 240h
3	High temperature & high humidity operation test	Ta=40°C ; 95%RH 240h (No condensation)
4	High temperature operation test	Topp=70°C 240h(Panel surface temperature)
5	Low temperature operation test	Ta=0°C 240h
6	Vibration test (non- operating)	Frequency : 10~57Hz/Vibration width (one side):0.075mm : 58~500Hz/Gravity:9.8m/s ² Sweep time : 11 minutes Test period : 3 hours (1 hour for each direction of X,Y,Z)
7	Shock test (non- operating)	Max. gravity : 490m/s ² Pulse width : 11ms, half sine wave Direction : ±X, ±Y, ±Z once for each direction.

【Result Evaluation Criteria】

Under the display quality test conditions with normal operation state, these shall be no change which may affect practical display function.

14. Others

- 1) Adjusting volume have been set optimally before shipment, so do not change any adjusted value.
If adjusted value is changed, the specification may not be satisfied.
- 2) Disassembling the module can cause permanent damage and should be strictly avoided.
- 3) Please be careful since image retention may occur when a fixed pattern is displayed for a long time.
- 4) If any problem occurs in relation to the description of this specification , it shall be resolved through discussion with spirit of cooperation.
- 5) Do not use LCD module in the atmosphere of corrosive gases, such as sulfide gas or chlorine gases.

of

LCD module. At high temperature, these compounds produce corrosive gases.

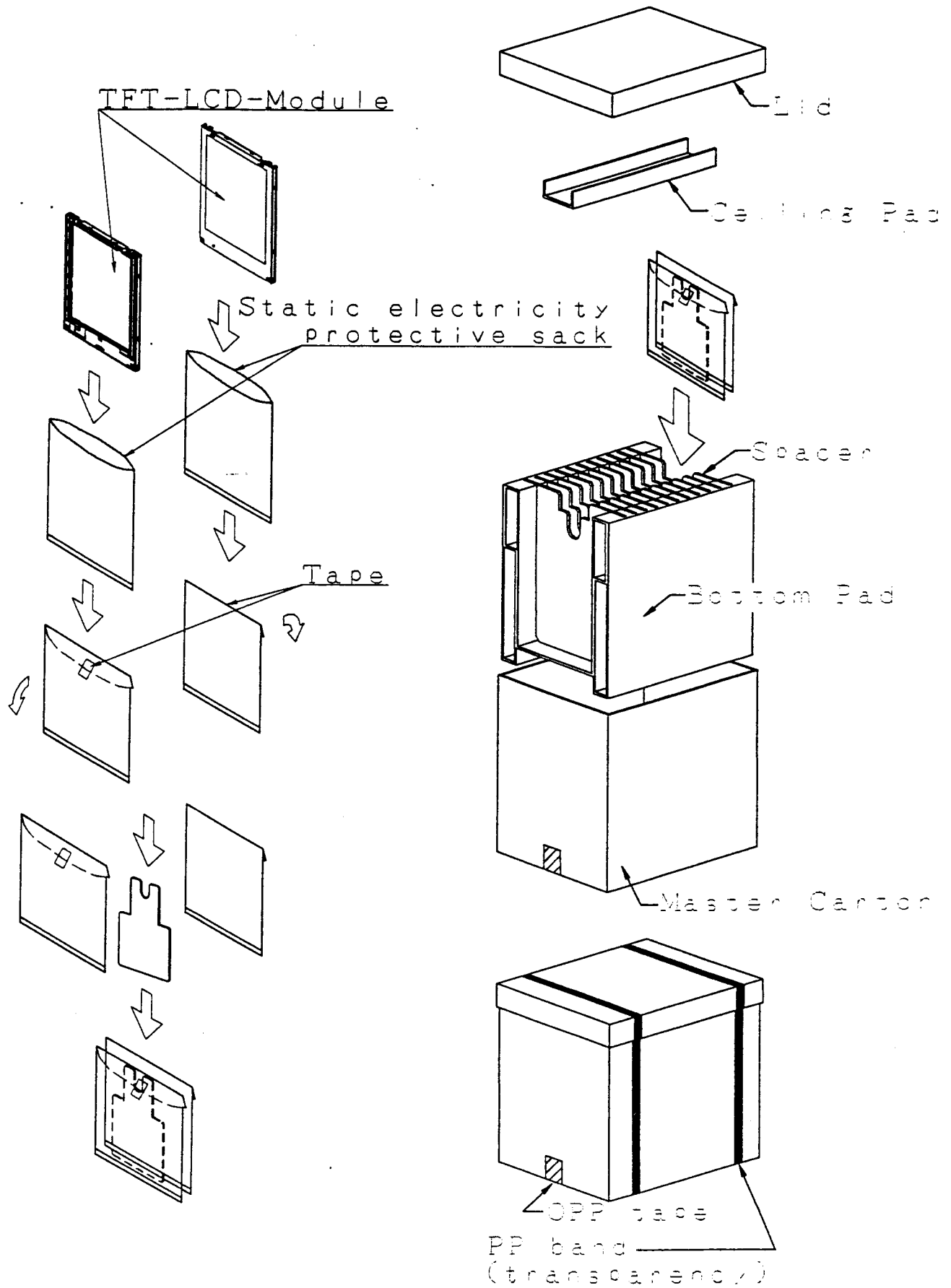

Packing Form

