

LQ150X1MW21

TFT LCD Module

(Model No.: LQ150X1MW21)

Spec. Issue Date: February 14, 2002

1. Application

This specification applies to a color TFT-LCD module, LQ150X1MW21 (15"XGA all in one module.).

- ◎These specification sheets are the proprietary product of SHARP CORPORATION("SHARP) and include materials protected under copyright of SHARP. Do not reproduce or cause any third party to reproduce them in any form or by any means, electronic or mechanical, for any purpose, in whole or in part, without the express written permission of SHARP .
- ◎The device listed in these technical sheets was designed and manufactured for use in OA equipment .
- ◎There are some of graphic cards which do not satisfy a standard. When such a card is used, it may not work properly.
- ◎In case of using the device for applications such as control and safety equipment for transportation(aircraft, trains, automobiles, etc.), rescue and security equipment and various safety related equipment which require higher reliability and safety, take into consideration that appropriate measures such as fail-safe functions and redundant system design should be taken .
- ◎Do not use the device for equipment that requires an extreme level of reliability, such as aerospace applications, telecommunication equipment(trunk lines), nuclear power control equipment and medical or other equipment for life support .
- ◎SHARP assumes no responsibility for any damage resulting from the use of the device which does not comply with the instructions and the precautions specified in these technical sheets .
- ◎Contact and consult with a SHARP sales representative for any questions about this device .

2. Overview

This module is a all in one model using a color active matrix LCD module incorporating amorphous silicon TFT (Thin Film Transistor). It is composed of a color TFT-LCD panel, driver ICs, control circuit, power supply circuit, monitor interface circuit, inverter circuit and a back light unit. Graphics and texts can be displayed on a 1024×3×768 dots panel with 16.7million colors by supplying analog video input or digital video input (DVI-D), with +12V DC supply voltage.

It is a wide viewing-angle-module (Vertical viewing angle: 170° Horizontal viewing angle: 170° , CR≥10).

This LCD module with new color filter is suitable for the LCD monitor applications where high vivid color saturation, and high color depth are very important.

3. Mechanical Specifications

Parameter	Specifications	Unit
Display size	38 (Diagonal)	cm
	15.0 (Diagonal)	inch
Active area	304.1 (H)×228.1 (V)	mm
Pixel format	1024 (H)×768 (V)	pixel
	(1 pixel=R+G+B dots)	
Pixel pitch	0.297 (H)×0.297 (V)	mm
Pixel configuration	R,G,B vertical stripe	
Display mode	Normally black	
Unit outline dimensions	340.0 (W)×264.0 (H)×42.5 (D)	mm
Mass	2150 (Maximum)	g
Surface treatment	Anti-glare and hard-coating 2H (Haze value = 28)	

*1.Note: outline dimension is shown in Fig. 1 , Fig. 2

4. Block Diagram (Fig. 3)

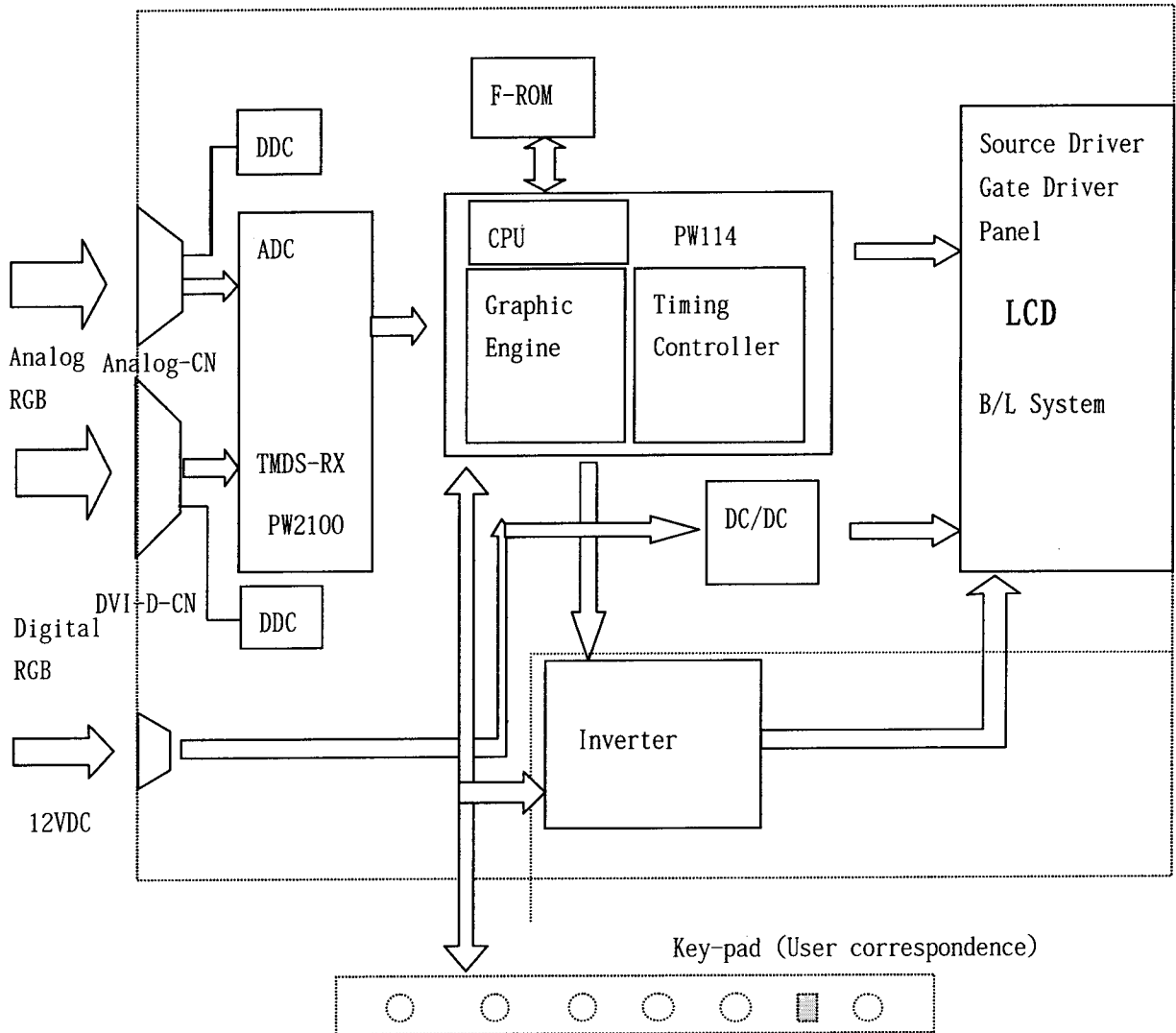

5. Input Terminals

5-1. Analog video input

CN1

The module-side connector : XM4L-1542-502B(OMRON) or equivalent

The user-side connector : Mini D-sub 15pin

Pin No.	Symbol	Signal	Remark
1	RV	Red Video	
2	GV	Green Video / Sync on Green	
3	BV	Blue Video	
4	PT	Open	
5	RT	Return	
6	RG	RED GND	
7	GG	Green GND	
8	BG	Blue GND	
9	+5V	+5VDC (for cable detect)	
10	SG	Sync GND	
11	OPT	GND	
12	SDA	Bidirectional DDC Data (SDA)	
13	HS	Horizontal Sync	
14	VS	Vertical Sync	
15	SCL	DDC Data Clock (SCL)	

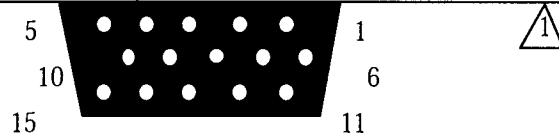

5-2. Digital video input

CN2

The module-side connector : 74320-4004 (MOLEX) or equivalent

The user-side connector : DVI-D 24pin

Pin No.	Symbol	Signal	Remark
1	TX2-	TMDS data2-	
2	TX2+	TMDS data2+	
3	SHLD2/4	Data2/4 Shield	
4		Reserved	
5		Reserved	
6	DDC CLK	DDC clock	
7	DDC Data	DDC data	
8	N.C.	Open	
9	TX1-	TMDS data1-	
10	TX1+	TMDS data1+	
11	SHLD1/3	Data1/3 Shield	
12		Reserved	
13		Reserved	
14	+5V	+5V	
15	GND	GND (Return for +5V, Hsync, and Vsync)	
16	HPD	Hot Plug Detect	
17	TX0-	TMDS data0-	
18	TX0+	TMDS data0+	
19	SHLD0/5	TMDS Data0/5 Shield	
20		Reserved	
21		Reserved	
22	TX CLK SHLD	TMDS Clock Shield	
23	TX CLK+	TMDS Clock+	
24	TX CLK-	TMDS Clock-	

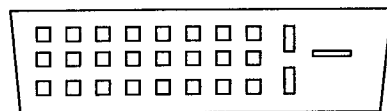

17

24

5-3. Power Input

CN3

The module-side connector : HEC0470-01-630 (HOSIDEN) or equivalent

The user-side connector : JXP1519 (HOSIDEN) or equivalent

Pin no.	symbol	Signal
1	Vin	+12V input
2	GND	GND



- 1. Vin
- 2. GND

6. Absolute Maximum Ratings

Parameter	Symbol	Condition	Ratings	Unit	Remark
Input voltage (Analog)	V_{ia}	$T_a=25^{\circ}C$	0 ~ +3.6	V	【Note1】
(DVI)	V_{id}	$T_a=25^{\circ}C$	-0.3 ~ +3.6	V	【Note1】
(Signal)	V_{is}	$T_a=25^{\circ}C$	-0.3 ~ +5.5	V	【Note1】
+12V supply voltage	V_{cc}	$T_a=25^{\circ}C$	0 ~ + 15	V	
Storage temperature	T_{stg}	—	-25 ~ +60	$^{\circ}C$	【Note2】
Operating temperature (Ambient)	T_{opa}	—	0 ~ +50	$^{\circ}C$	

Stresses above those listed under “Absolute Maximum Ratings “ may cause permanent damage to the module.

【Note1】 For signals

【Note2】 Humidity : 95%RH Max. ($T_a \leq 40^{\circ}C$)

Maximum wet-bulb temperature at $39^{\circ}C$ or less ($T_a > 40^{\circ}C$)

No condensation.

7. Electrical Characteristics

7-1. Analog Video Input (15-pin VGA)

Standard : VESA

Analog video signals : 0.7Vp-p 75 Ohm



DDC: L; Max0.8V H; Min2.0V

Other signals : 3.3 and 5V TTL logic families (Separate Sync, Sync on Green, Composite)

7-2. Digital Video Input (24-PIN DIGITAL)

DVI1.0 compliant

TMDS signals : Follow spec. of DVI1.0

DDC: L; Max1.5V H; Min3.85V

Other signals : 3.3 and 5V TTL logic families

* There are some of graphic cards which do not satisfy a standard.
When such a card is used, it may not work properly.

7-3. Power Input

	Parameter	Symbol	Min.	Typ.	Max.	Unit	Remark
+12V	Supply voltage	V _{in}	11.4	12.0	12.6	V	
	Current dissipation	I _{in}		1.7	2.0	A	
	Ripple Voltage				200	mV	

7-4. Back light driving

The back light system is an edge-lighting type with four CCFT (Cold Cathode Fluorescent Tube).

The characteristics of the lamp are shown in the following table .

The value mentioned below is at the case of one CCFT .

Parameter	Symbol	Min.	Typ.	Max.	Unit	Remark
Lamp life time	L _L	50000	—	—	hour	【Note1】

【Note1】 Lamp life time is defined as the time when either ① or ② occurs in the continuous operation under the condition of T_a=25°C and I_L=6.2 mArms.

- ① Brightness becomes 50% of the original value under standard condition .
- ② Kick-off voltage at T_a=0°C exceeds maximum value, 1400Vrms .

8. VESA DPMS FUNCTIONALITY

VESA DPMS specification

9. Display Resolution

Vertical frequency : From 58 to 75.03Hz

Horizontal frequency : From 31.47 to 60 KHz

If the input frequency is out of the above-specified range, the Smart Panel shall display a warning screen

Timing characteristics of input signals factory preset display mode

FACTORY PRESET DISPLAY MODES

Preset	Pixel Format	H-Freq (KHz)	H Polarity	V-Freq (Hz)	V Polarity	Pixel Clk (MHz)	Source
1	640 x 350	31.47	+	70.09	-	25.175	VGA
2	640 x 480	31.47	-	59.94	-	25.175	VGA
3	640 x 480	37.50	-	75.00	-	31.500	VESA
4	720 x 400	31.47	-	70.08	+	28.321	VGA
5	800 x 600	37.88	+	60.32	+	40.000	VESA
6	800 x 600	46.88	+	75.00	+	49.500	VESA
7	832 x 624	49.72	+/-	74.55	+/-	57.283	MAC
8	1024 x 768	48.36	-	60.00	-	65.000	VESA
9	1024 x 768	56.50	-	70.00	-	75.000	VESA
10	1024 x 768	60.02	+	75.03	+	78.750	VESA

10. CONTROLLER FUNCTION

/Video Stretching and Down Scaling

/Auto Correction -- display size, position, clock, Phase adjustment

/Panel Timing and Interface

/Controller ASICS -PW114

11. Output for Key-pad for Operation(CN4)

Connector:SD53261-1510(molex)



No	Name	Signal	Key Function
1	N.C.	N.C.	
2	N.C.	N.C.	
3	N.C.	N.C.	
4	GND	GND	
5	LEDG-ON	Green LED ON SIGNAL	
6	LEDO-ON	Red LED ON SIGNAL Key	
7	N.C.	N.C.	
8	N.C.	N.C.	
9	KB5	Key Input 5	SELECT
10	KB4	Input 4	-
11	KB3	Key Input 3	+
12	KB2	Key Input 2	MENU
13	KB1	Key Input 1	POWER
14	KB0	Key Input 0	INPUT
15	+5V	+5V output	

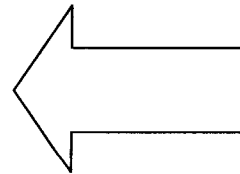
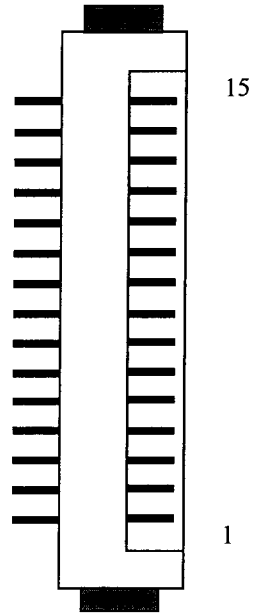

12. OSD MENU

MENU	FUNCTION		Analog Input	Digital Input	REMARK
MENU1 ADJUSTMENT	MANUAL	CLOCK	*	-	
		PHASE	*	-	
		H-POS	*	-	
		V-POS	*	-	
	AUTO		*	-	Auto Adjust
MENU2 GAIN CONTROL	MANUAL	BLACK LEVEL	*	-	
		CONTRAST	*	-	
	AUTO		*	-	Auto Adjust
MENU3	WHITE BALANCE		*	*	5 step COOL-STD-WARM, USER
MENU4 MODE SELECT	OSD H-POSITION		*	*	
	OSD V-POSITION		*	*	
	400 LINE		*	-	
	EXPAND		*	*	
	SCALING		*	*	
	LANGUAGE		*	*	English, Deutsch, Español, Français , Italiano, Nether land, Svenska

(Key Function)

* INPUT : Select "Analog input" or "Digital input"

* MENU : Change "OSD Menu" (MENU1 – MENU4)

* SELECT : Select items on OSD

* + : When OSD Menu is not displayed = Increase brightness

When OSD Menu is displayed = Change value on OSD

* - : When OSD Menu is not displayed = Decrease brightness

When OSD Menu is displayed = Change value on OSD

13. Operation method of OSD

【When analog signal used】

- 1) To use auto adjustment” at first. (Page.3)
- 2) To use manual adjustment, if necessary. (Page.4)

【When digital signal used】

Basically, user can use without adjustment. Manual adjustment can be used, if necessary. (Page.8)

[Memo]

Adjustment record can be sustained even after the power- off. (However, it might not be sustained if the power is turned off when the adjustment menu is shown on the display.)

13-1. Backlight Brightness Adjustment

User needs to operate when adjustment menu is not shown on display. If the adjustment menu is shown on the display, the user needs to press “MENU” button (some times, occasionally) to disappear it, at first.

- * Manual adjustment can not be worked out when auto adjustment (“AUTO”) is set. In this case, user needs to change the setting to the others (“LOW”/”MID”/”HIGH”) at first.

<Manual Adjustment>

- i)To press “-“ or “+” button when the adjustment menu is not shown on the display.



- ii)To press “-“ button (for darker image), or “+” button (for brighter) for the adjustment.

The adjustment bar automatically disappears some seconds after the user’s last operation.

13-2. Adjustment Lock Function

The operation buttons can be locked (Lock Function) to avoid the change after the completion of the adjustment

- i)To turn off the power supply of main body.
- ii)To press the power supply button (to turn on) with “MENU” button pushed. Please press the button continuously until message is appeared on the display.

When the lock function is not activated...

The lock function becomes activated with “ADJUSTMENT LOCKED” shown on the display.

When the lock function is activated...

The lock function becomes cancelled with “ADJUSTMENT UNLOCKED” shown on the display

[MEMO]

When the lock function is activated, the buttons except for the power button can not be worked out.

13-3. Reset of adjustment value

<Reset of ADJUSTMENT menu>

【When analog signal used】

The adjustment value of ADJUSTMENT menu can be returned back to the initial condition, which was set up in the time of the factory's shipping.

i)To turn on the power supply.

ii)To press both "MENU" button and "-" button. Reset is completed with "RESET" shown on the display.

<All reset of adjustment value>

All of the adjustment menu can be returned back to the initial condition, which is set up in the time of the factory's shipping.

i)To turn off the power supply.

ii)To press the power supply button (to turn on) with both "MENU" button and "SELECT" button pressed.

Please press the buttons continuously until "ALL RESET" is shown on the display. When "ALL RESET END" is shown, reset is completed.

iii)After reset completed, please turn off the power supply once.

[MEMO]

* When "ALL RESET" is shown on the display, the operation button can not be worked out.

* When the adjustment lock is activated, all reset can not be worked out. In this case, please unlock the adjustment lock, at first.

13-4. Display Imaging Adjustment 【When analog signal used】**13-4-1. Auto adjustment of display**

"CLOCK", "PHASE", "H-POS"(Horizontal position) and "V-POS"(Vertical position) in "ADJUSTMNT" menu are automatically adjusted.

[Memo]

Please make auto adjustment activated before the use when user uses this display for the first time, or when user changed the setting in use.

* Please show the image, which has cross-lines on display area and white lines on edge of display area, on the display before auto adjustment activated.

<How to adjust>

i) To press "MENU" button. "ADJUSTMENT" menu is shown.

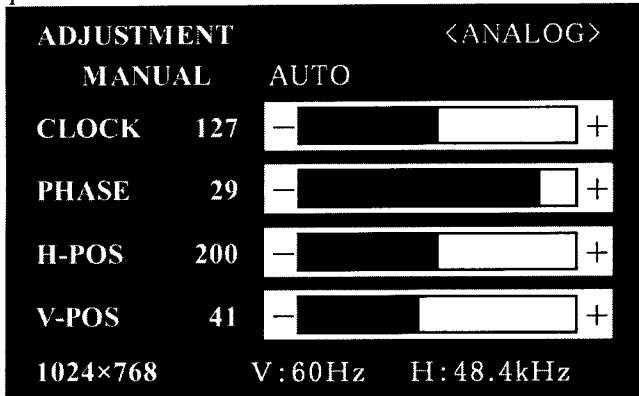

ii) To press "+" button. The display turns black with "ADJUSTING" shown, then comes back to "ADJUSTMENT" menu. (Auto adjustment is completed at this time.)

iii) To press "MENU" button four times so that adjustment menu can disappear.

[Memo]

* Usually, auto adjustment only is enough to use.

* In the following case even after auto adjustment made, please use manual adjustment (P.4) if necessary.

/ When user would like to adjust a little more.

/ When computer signal is such as composite sync or sync on green (In this case, it might not be adjusted appropriately by auto adjustment.)

/ When "OUT OF ADJUST" is shown on the display. [Depending on the display image (ex. too dark image), auto adjustment can not be worked out. Please show the image which has brighter lines before auto adjustment activated again.]

13-4-2. Manual Adjustment of display

Users can adjust the display image by using the adjustment menu which is prepared.

<Display Image for adjustment>

Please show the image, which has cross-lines on display area and white lines on edge of display area, on the display, and then adjust by seeing the display image.

<How to adjust>

i) To press "MENU" button. "ADJUSTMENT" menu is shown on the display.

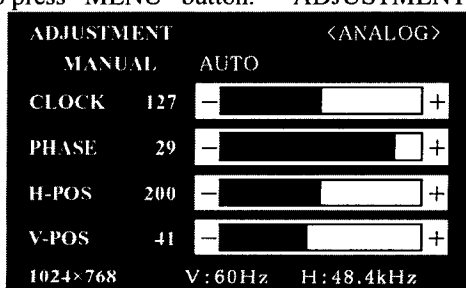

After then, user can adjust the item which needs to be change. Everytime you press “MENU” button, it is switched. (ADJUSTMENT → GAIN CONTROL → WHITE BALANCE → MODE SELECT → to make the menu disappear)

[MEMO]

The adjustment menu automatically disappears approx. 30 seconds after the user’s last operation

<ADJUSTMENT menu>

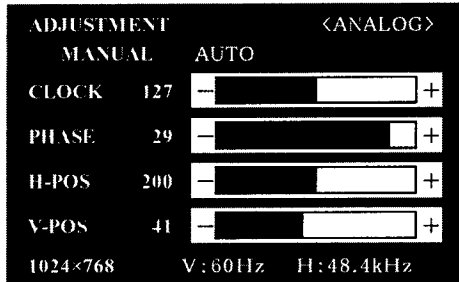

MANUAL...To adjust the item manually which needs to be changed.

AUTO.....To adjust each item automatically

- * To select “AUTO” by pressing “+” button.
- * To select the item : “SELECT” button
- * To next menu: : “MENU” button

CLOCK

Please adjust to make the noise of vertical strips. (“+” “-“ button)

PHASE

Please adjust to make the noise of horizontal strips. (“+” “-“ button)

- * Please note that “PHASE” adjustment needs to be after “CLOCK” adjustment done appropriately.

H-POS(Horizontal Position), V-POS(Vertical Position)

Please adjust horizontal(H-POS) and vertical(V-POS) position so that all of the picture can be shown in the display. (“+” “-“ button)

<GAIN CONTROL menu>

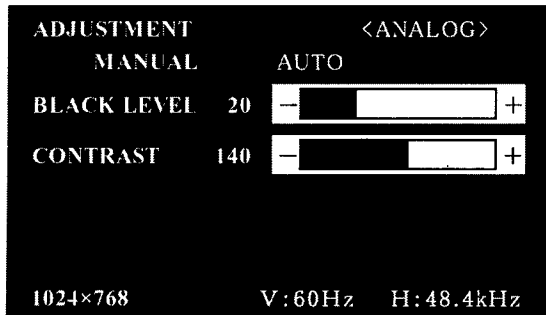

MANUAL...To adjust the item manually which needs to be changed.

AUTO.....To adjust “BLACK LEVEL” and “CONTRAST” automatically by “Auto Gain Control” function. Please use manual adjustment after auto adjustment, if necessary.

- * To select “AUTO” by pressing “+” button.

* To select the item : “SELECT” button

* To go to next menu : “MENU” button

<“Auto Gain Control” function>

/ Black level and Contrast are adjusted based upon the brightest color and the darkest color in the image shown on display. More than 5mm × 5mm imaging of black and white needs to be shown on the display. Otherwise, it might not be adjusted appropriately.

/ When the signal from computer is composite sync or sync on green, auto adjustment might not be worked out. In the case, please use manual adjustment.

BLACK LEVEL

Please adjust the brightness of all the display. (“+” “-“ button)

CONTRAST

Please adjust so that all of gray scale can be displayed. (“+” “-“ button)

<WHITE BALANCE menu>

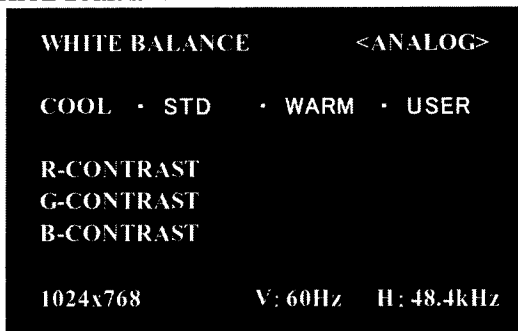

* Please set up “STD” to show all of gray scale. Without “STD”, all of gray scale can not be shown.

* To select “COOL”, “·”, “STD”, “·”, “WARM” or “USER” by “+” “-“ button.

* If “USER” is selected, the setting value of “R-CONTRAST”, “G-CONTRAST” and “B-CONTRAST” is shown, and can be tuned in exactly.

* To select “R-CONTRAST”, “G-CONTRAST” or “B-CONTRAST” by “SELCT” button.

* To go to next menu : “MENU” button

COOL..... Bluish from standard

• A little bluish from standard

STD..... Standard setting

• A little reddish from standard

WARM.... Reddish from standard

USER

R-CONTRAST..... Cyan by “-“ button

Red by “+” button

G-CONTRAST..... Magenta by “-“ button

Green by “+” button

B-CONTRAST..... Yellow by “-“ button
 Blue by “+” button

<MODE SELECT menu>

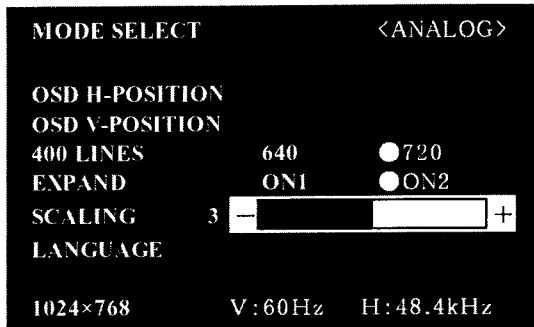

* Depending on the resolution of input signal, the display condition might not be changed even if the item can be selected.

* To select the item : SELECT button

* To finish adjustment : MNU button

OSD H-POSITION

To shift the position of adjustment menu horizontally. (“+” “-“ button)

OSD V-POSITION

To shift the position of adjustment menu vertically. (“+” “-“ button)

400 LINES (resolution)

To set the horizontal resolution of 400 line imaging in PC9800 series and US TEXT etc. (“+” “-“ button)

640....640×400 dots mode (PC 9800 series etc.)

720....720×400 dots mode (US TEXT etc.)

* When the input resolution is other than 400 line, user does not need to set because it can be automatically detected.

EXPAND

To select the expansion of the display image with less than 1024×768 dots of display mode. (“+” “-“ button)

ON1... To expand with ratio near aspect ratio.

ON2... To expand all parts of the display imaging.

* When the resolution does not become 1024×768 even after the imaging expansion, the surrounding of display can be shown in black. (This is not out of order.)

SCALING

To adjust the sharpness of the expanded display imaging. (“+” “-“ button)

LANGUAGE

To change the language used in the adjustment menu.

i) To press “+” button

ii) To select the language by “SELECT” button. Language select menu (“LANGUAGE”) is shown.

iii) To press “MENU” button or “+” button to make the language select menu disappear.

13-5. Display imaging adjustment **【When digital signal used】**

<How to adjust>

User can adjust the display image by using the adjustment menu which is prepared.

13-5-1. Display Image for adjustment

Please show the image, which makes all parts of display bright, on the display, and then adjust by seeing the display image.

<How to adjust>

i) To press “MENU” button. WHITE BALANCE menu is shown on the display.

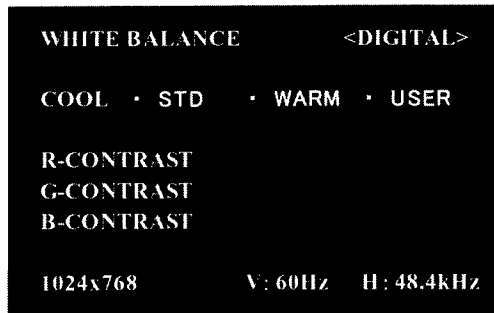

After then, user can adjust the item which needs to be change. Everytime you press “MENU” button, it is switched. (WHITE BALANCE → MODE SELECT → to make the menu disappear)

[Memo]

The adjustment menu automatically disappears approx. 30 seconds after the user’s last operation

<WHITE BALANCE menu>

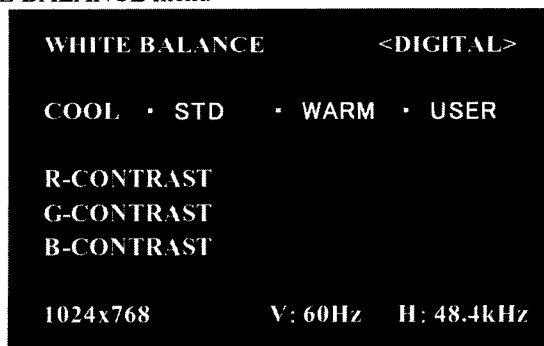

* Please set up “STD” to show all of gray scale. Without “STD”, all of gray scale can not be shown.

* To select “COOL”, “STD”, “WARM” or “USER” by “+” “-“ button.

* If “USER” is selected, the setting value of “R-CONTRAST”, “G-CONTRAST” and “B-CONTRAST” is shown, and can be adjusted a little.

* To select “R-CONTRAST”, “G-CONTRAST” or “B-CONTRAST” by “SELCT” button.

* To go to next menu : “MENU” button

COOL..... Bluish from standard

- A little bluish from standard

STD..... Standard setting

- A little reddish from standard

WARM.... Reddish from standard

USER

R-CONTRAST..... Cyan by “-“ button

Red by “+” button

G-CONTRAST..... Magenta by “-“ button

Green by “+” button

B-CONTRAST..... Yellow by “-“ button

Blue by “+” button

<MODE SELECT menu>

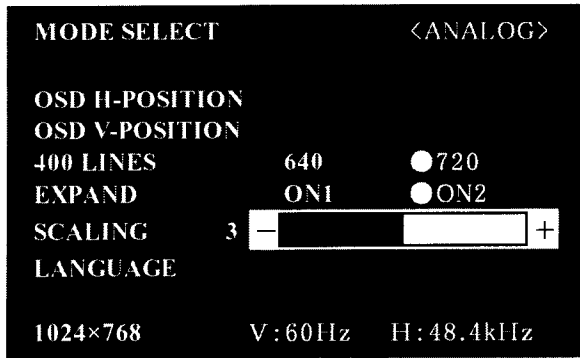

* Depending on the resolution of input signal, the display condition might not be changed even if the item can be selected.

* To select the item : SELECT button

* To finish adjustment : MNU button

OSD H-POSITION

To shift the position of adjustment menu horizontally. (“+” “-“ button)

OSD V-POSITION

To shift the position of adjustment menu vertically. (“+” “-“ button)

EXPAND

To select the expansion of the display image with less than 1024×768 dots of display mode. (“+” “-“ button)

ON1... To expand with ratio near aspect ratio.

ON2... To expand all parts of the display imaging.

* When the resolution does not become 1024×768 even after the imaging expansion, the surrounding of display can be shown in black. (This is not out of order.)

SCALING

To adjust the sharpness of the expanded display imaging. (“+” “-“ button)

LANGUAGE

To change the language used in the adjustment menu.

i) To press “+” button

ii) To select the language by “SELECT” button. Language select menu (“LANGUAGE”) is shown.

iii) To press “MENU” button or “+” button to make the language select menu disappear.

14. Optical Characteristics

Ta=25°C

Parameter		Symbol	Condition	Min.	Typ.	Max.	Unit	Remark
View Angle Range	Horizontal	$\theta 21, \theta 22$	$CR \geq 10$	70	85	—	Deg.	【Note1,4,6】
	Vertical	$\theta 11$		70	85	—	Deg.	
		$\theta 12$		70	85	—	Deg.	
Contrast ratio		C R n	$\theta = 0^\circ$	250	400	—		【Note2,4,6】
Response Time	Rise	τr	$\theta = 0^\circ$	—	20	50	m s	【Note3,4】
	Decay	τd		—	5	25	m s	
Chromaticity of White		x		0.283	0.313	0.343	—	【Note4】
		y		0.299	0.329	0.359	—	
Chromaticity of Red		x		0.607	0.637	0.667	—	
		y		0.309	0.339	0.369	—	
Chromaticity of Green		x		0.245	0.275	0.305	—	
		y		0.575	0.605	0.635	—	
Chromaticity of Blue		x		0.115	0.145	0.175	—	
		y		0.057	0.087	0.117	—	
Luminance of white		Y_{L1}	240	300	—	cd/m ²	【Note4,6】	
White Uniformity		δ_w	—	—	1.25		【Note5】	

※The measurement shall be executed 30 minutes after lighting at rating

※The optical characteristics shall be measured in a dark room or equivalent state with the method Shown in Fig.6 below .

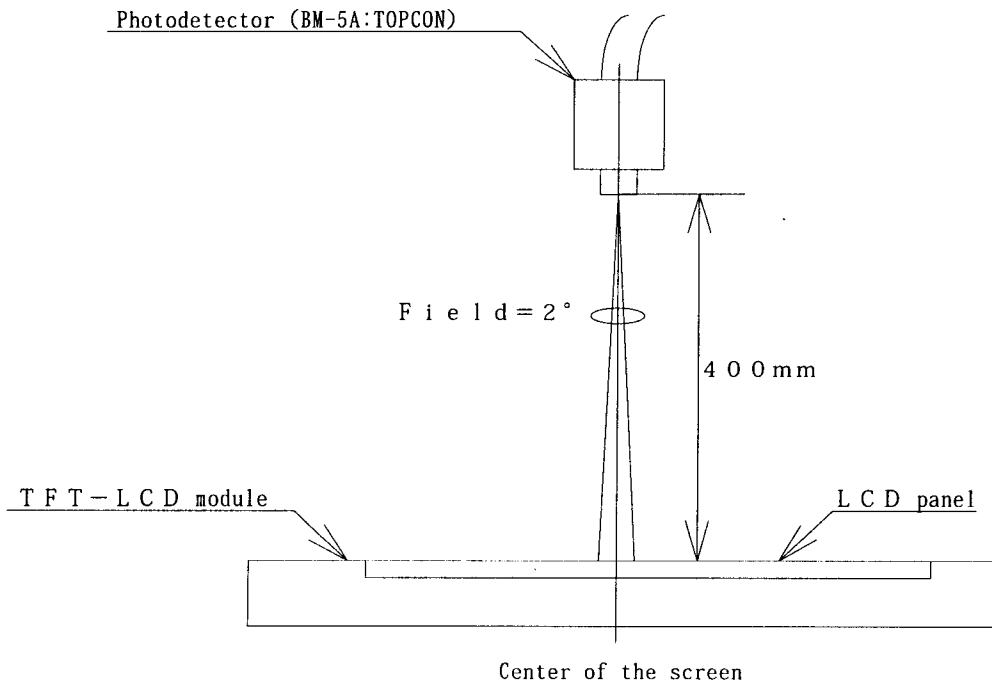
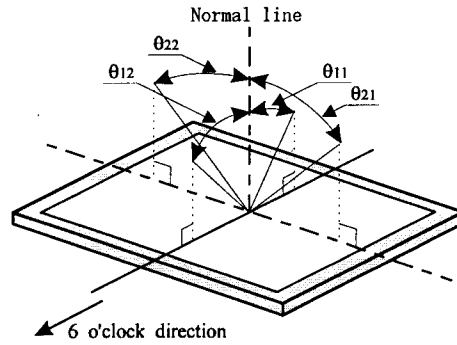

Fig.6 Optical characteristics measurement method

【Note1】 Definitions of viewing angle range:



【Note2】 Definition of contrast ratio:

The contrast ratio is defined as the following.

$$\text{Contrast Ratio (CR)} = \frac{\text{Luminance (brightness) with all pixels white}}{\text{Luminance (brightness) with all pixels black}}$$

【Note3】 Definition of response time:

The response time is defined as the following figure and shall be measured by switching the input signal for "black" and "white" .

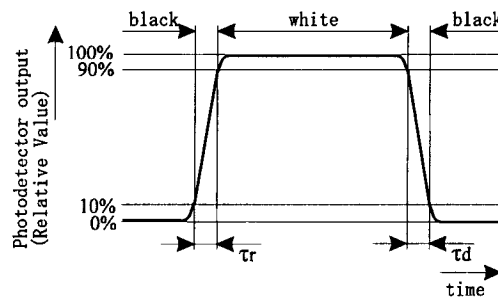

【Note4】 This shall be measured at center of the screen .

【Note5】 Definition of white uniformity:

White uniformity is defined as the following five measurements (A~E) at right figure and calculation with following formula.

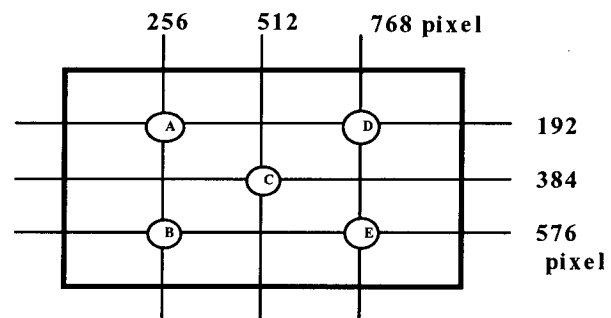

$$\delta_w = \frac{\text{Maximum Luminance of five points (brightness)}}{\text{Minimum Luminance of five points (brightness)}}$$

【Note6】 Measurement Condition

COLOR = STD

15. Handling Precautions

- a) Be sure to turn off the power supply when inserting or disconnecting the cable.
- b) Be sure to design the cabinet so that the module can be installed without any extra stress such as warp or twist.
- c) Since the front polarize is easily damaged, pay attention not to scratch it.
- d) Since long contact with water may cause discoloration or spots, wipe off water drop immediately.
- e) When the panel surface is soiled, wipe it with absorbent cotton or other soft cloth. .
- f) Since the panel is made of glass, it may break or crack if dropped or bumped on hard surface. Handle with care.
- g) Since CMOS LSI is used in this module, take care of static electricity and take the human earth into consideration when handling.
- h) Observe all other precautionary requirements in handling components.
- i) This module has its circuitry PCBs on the rear side and should be handled carefully in order not to be stressed.
- j) When some pressure is added onto the module from rear side constantly, it causes display non-uniformity issue, functional defect, etc. So, please avoid such design.
- k) Because Inverter portion use very high voltage, please don't touch when it powered on.

17. Packing form

- a) Piling number of cartons : MAX. 5
- b) Package quantity in one carton : 5pcs
- c) Carton size : 392*380*315
- d) Packing form drawing : Fig. 7

16. Reliability test items

No.	Test item	Conditions
1	High temperature storage test	Ta=60°C 240h
2	Low temperature storage test	Ta=-25°C 240h
3	High temperature & high humidity operation test	Ta=40°C ; 95%RH 240h (No condensation)
4	High temperature operation test	Ta=50°C 240h (The panel temp. must be less than 60°C)
5	Low temperature operation test	Ta=0°C 240H
6	Vibration test (non- operating)	Frequency : 10~57Hz/Vibration width (one said) : 0.075mm : 58~500Hz/Gravity : 9.8m/s ² Sweep time : 11minutes Test period : 3 hours (1 hours for each direction X,Y,Z)
7	Shock test (non- operating)	Max, gravity : 490m/s ² Pulse width : 11 ms, sine wave Direction : ±X, ±Y, ±Z once for each direction

【Result Evaluation Criteria】

Under the display quality test conditions with normal operation state, these shall be no change which may affect practical display function .

17. Others

1) Lot No. and indication Label:

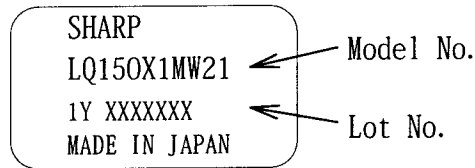

How to express Lot No.

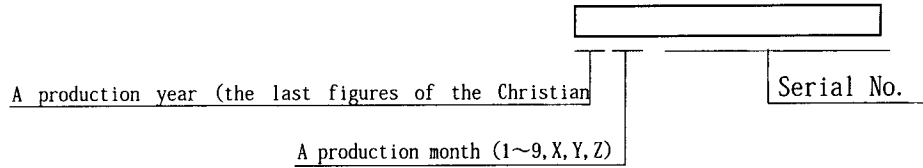

2) Packing box Label

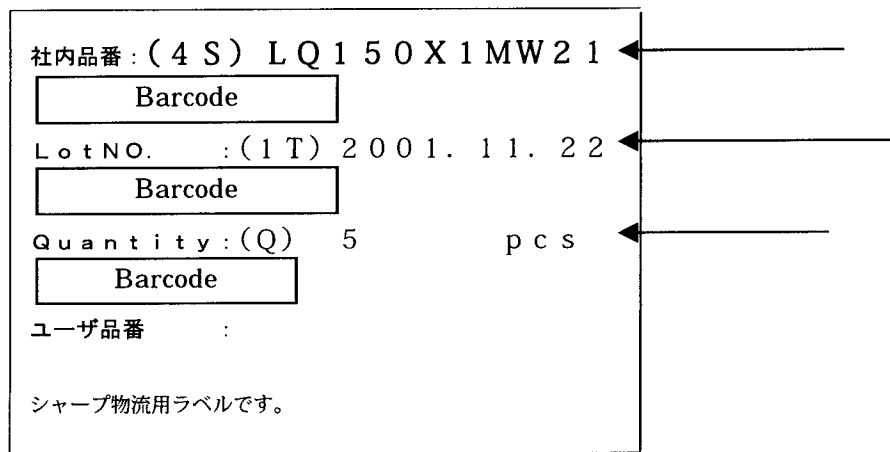

Model No.

And Barcode(Model No.)

Lot No. (Date)

And Barcode(Lot No.)

Quantity

And Barcode(Quantity)

3) Adjusting volume have been set optimally before shipment, so do not change any adjusted value

If adjusted value is changed, the specification may not be satisfied

4) Disassembling the module can cause permanent damage and should be strictly avoided

5) Please be careful since image retention may occur when a fixed pattern is displayed for a long time

6) Chemical compound which causes the destruction of ozone layer is not being used

7) Warning of mercury and material information of LPG(Light Pipe Guide) are labeled on the back of the module.

8)Cold Cathode Fluorescent Lamp in LCD Panel contains a small amount of Mercury , Please follow

Local Ordinance or Regulations for disposal

9)If any Problem occurs on relation on the description on this specification , it should be resolved through discussion with spirit of cooperation

LD-13Z03A-23

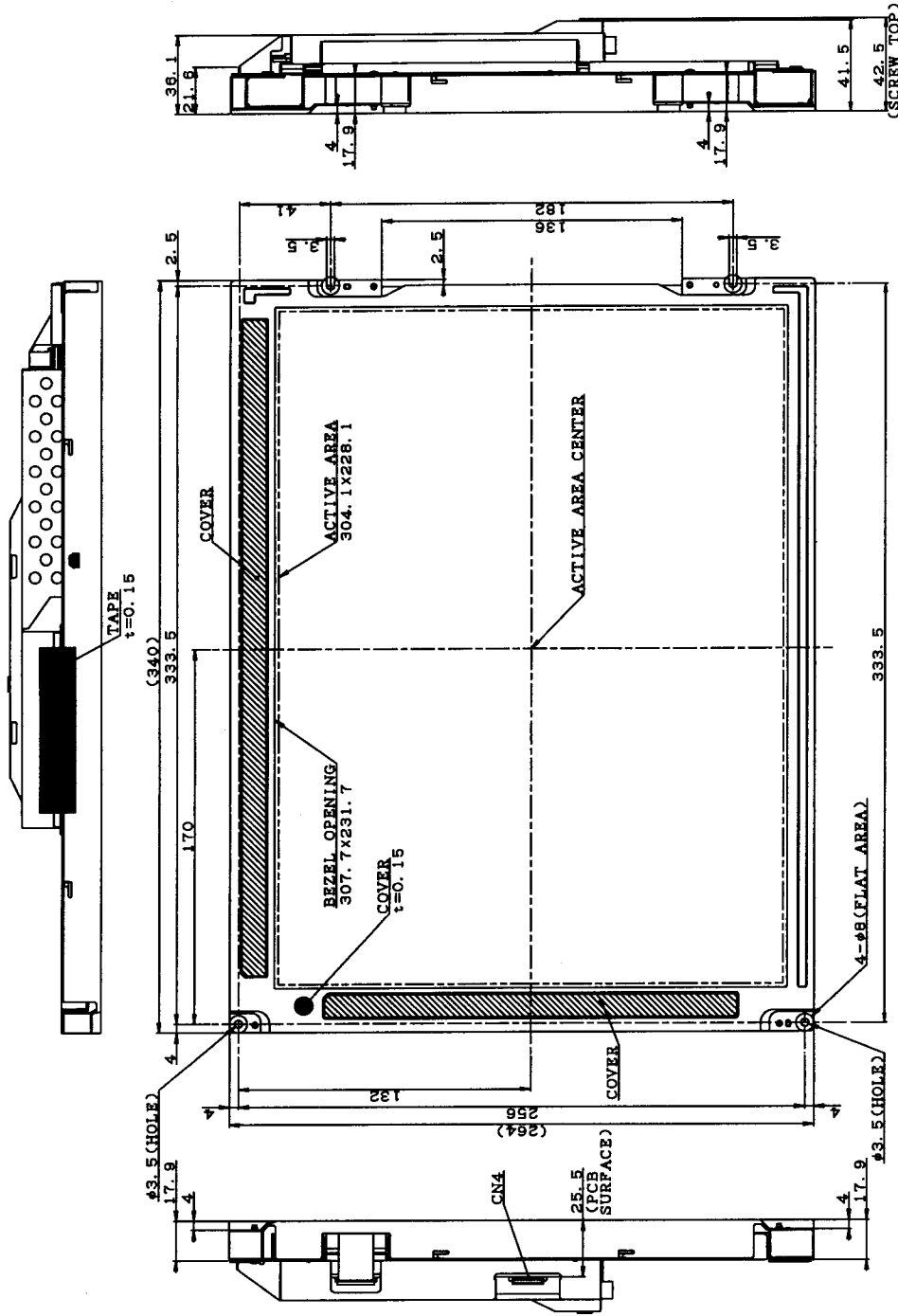

- NOTES
- 1) UNSPECIFIED TOLERANCE TO BE ± 0.5 .
 - 2) WARP AND FLATTING FOR PWB COVER AND CHASSIS ARE EXCLUDED FROM THICKNESS AND DIMENSION OF THE UNIT.
 - 3) UNIT: [mm]

Fig. 1 LQ150X1MW21 OUTLINE DIMENSIONS (FRONT SIDE)

DRAWING DAY: 2002/1/9

BEZEL/DISPLAY POSITION

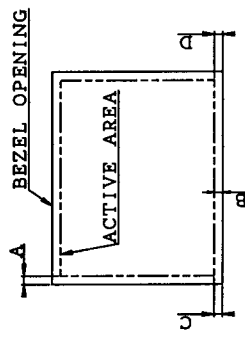

- 1) TOLERANCE X-DIRECTION A: 1.8 ± 0.8
- 2) TOLERANCE Y-DIRECTION B: 1.8 ± 0.8
- 3) OBLIQUITY OF DISPLAY AREA $|C-D| < 0.8$

LD-13Z03A-25

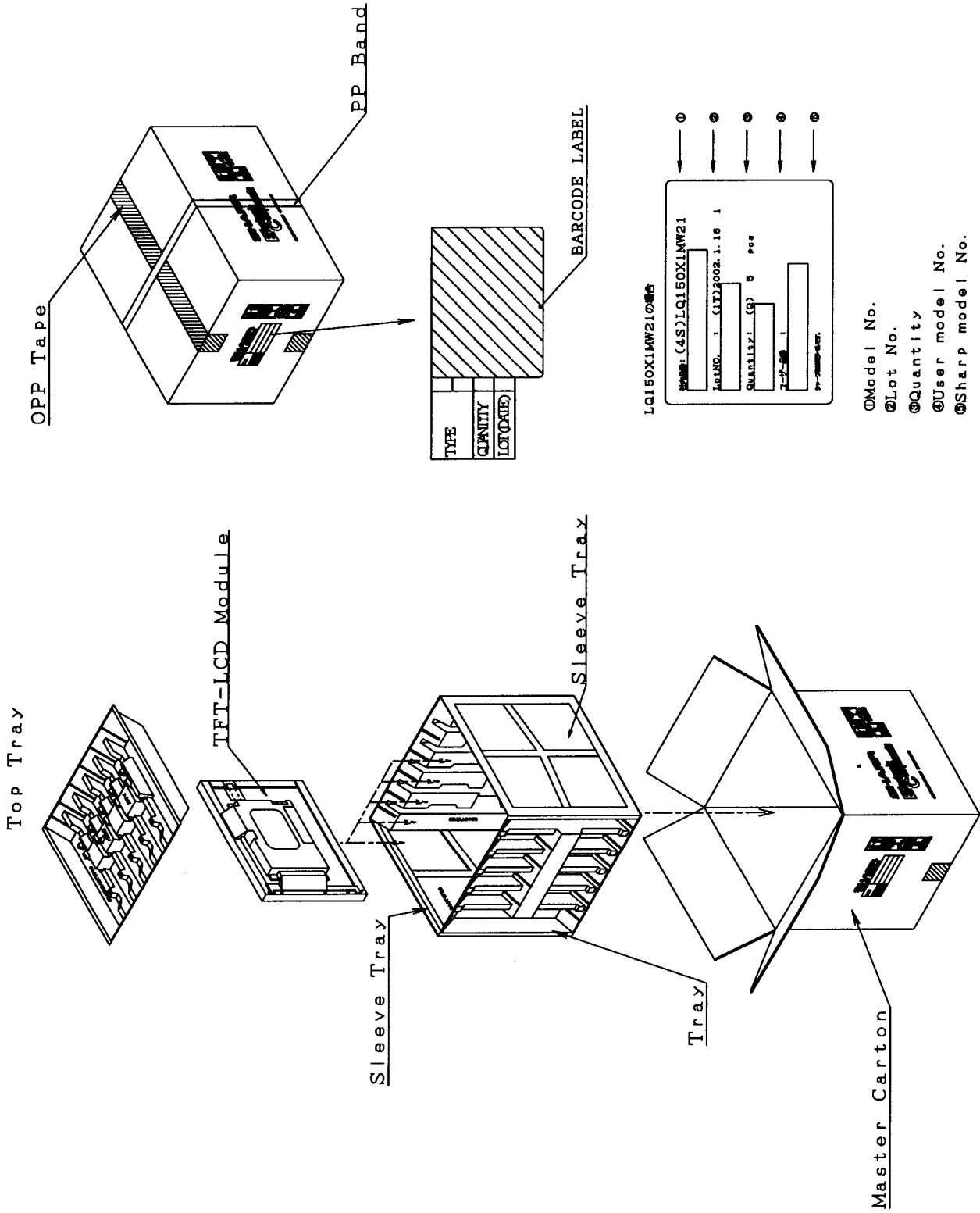

Packing Form

LD-13Z03A-26

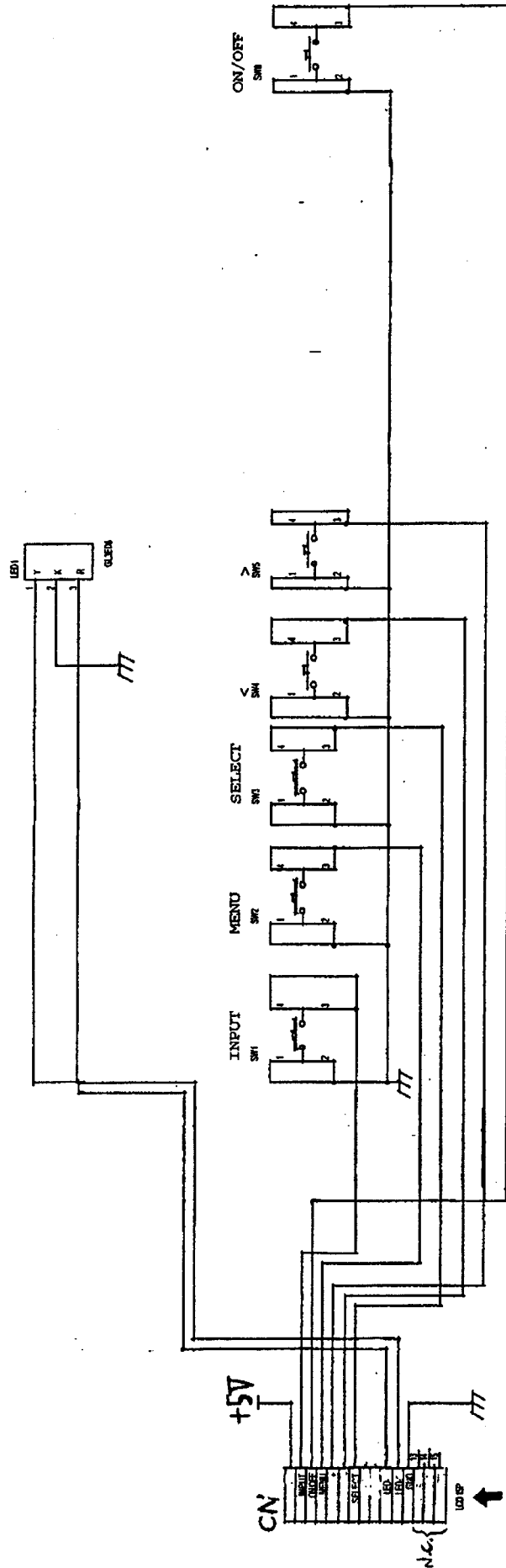

15	+V5
14	INPUT
13	POWER
12	MENU
11	+ (>)
10	- (>)
9	SELECT
8	N.C.
7	N.C.
6	LED-O
5	LED-G
4	GND
3	N.C.
2	N.C.
1	N.C.

Key Switch for LQ150X1MW21

SPECIFICATIONS ARE SUBJECT TO CHANGE WITHOUT NOTICE.

Suggested applications (if any) are for standard use; See Important Restrictions for limitations on special applications. See Limited Warranty for SHARP's product warranty. The Limited Warranty is in lieu, and exclusive of, all other warranties, express or implied. ALL EXPRESS AND IMPLIED WARRANTIES, INCLUDING THE WARRANTIES OF MERCHANTABILITY, FITNESS FOR USE AND FITNESS FOR A PARTICULAR PURPOSE, ARE SPECIFICALLY EXCLUDED. In no event will SHARP be liable, or in any way responsible, for any incidental or consequential economic or property damage.

SHARP®

NORTH AMERICA

SHARP Microelectronics of the Americas
5700 NW Pacific Rim Blvd.
Camas, WA 98607, U.S.A.
Phone: (1) 360-834-2500
Fax: (1) 360-834-8903
Fast Info: (1) 800-833-9437
www.sharpsma.com

EUROPE

SHARP Microelectronics Europe
Division of Sharp Electronics (Europe) GmbH
Sonninstrasse 3
20097 Hamburg, Germany
Phone: (49) 40-2376-2286
Fax: (49) 40-2376-2232
www.sharpsme.com

JAPAN

SHARP Corporation
Electronic Components & Devices
22-22 Nagaike-cho, Abeno-Ku
Osaka 545-8522, Japan
Phone: (81) 6-6621-1221
Fax: (81) 6117-725300/6117-725301
www.sharp-world.com

TAIWAN

SHARP Electronic Components
(Taiwan) Corporation
8F-A, No. 16, Sec. 4, Nanking E. Rd.
Taipei, Taiwan, Republic of China
Phone: (886) 2-2577-7341
Fax: (886) 2-2577-7326/2-2577-7328

SINGAPORE

SHARP Electronics (Singapore) PTE., Ltd.
438A, Alexandra Road, #05-01/02
Alexandra Technopark,
Singapore 119967
Phone: (65) 271-3566
Fax: (65) 271-3855

KOREA

SHARP Electronic Components
(Korea) Corporation
RM 501 Geosung B/D, 541
Dohwa-dong, Mapo-ku
Seoul 121-701, Korea
Phone: (82) 2-711-5813 ~ 8
Fax: (82) 2-711-5819

CHINA

SHARP Microelectronics of China
(Shanghai) Co., Ltd.
28 Xin Jin Qiao Road King Tower 16F
Pudong Shanghai, 201206 P.R. China
Phone: (86) 21-5854-7710/21-5834-6056
Fax: (86) 21-5854-4340/21-5834-6057

Head Office:

No. 360, Bashen Road,
Xin Development Bldg. 22
Waigaoqiao Free Trade Zone Shanghai
200131 P.R. China
Email: smc@china.global.sharp.co.jp

HONG KONG

SHARP-ROXY (Hong Kong) Ltd.
3rd Business Division,
17/F, Admiralty Centre, Tower 1
18 Harcourt Road, Hong Kong
Phone: (852) 28229311
Fax: (852) 28660779
www.sharp.com.hk

Shenzhen Representative Office:

Room 13B1, Tower C,
Electronics Science & Technology Building
Shen Nan Zhong Road
Shenzhen, P.R. China
Phone: (86) 755-3273731
Fax: (86) 755-3273735